



Frame Error Detection

รศ.ดร.อนันต์ ผลเพิ่ม

Asso. Prof. Anan Phonphoem, Ph.D.

anan.p@ku.ac.th

<http://www.cpe.ku.ac.th/~anan>

Computer Engineering Department

Kasetsart University, Bangkok, Thailand



Outline

- Transmission Errors
- Error Detection Mechanism

Transmission Errors

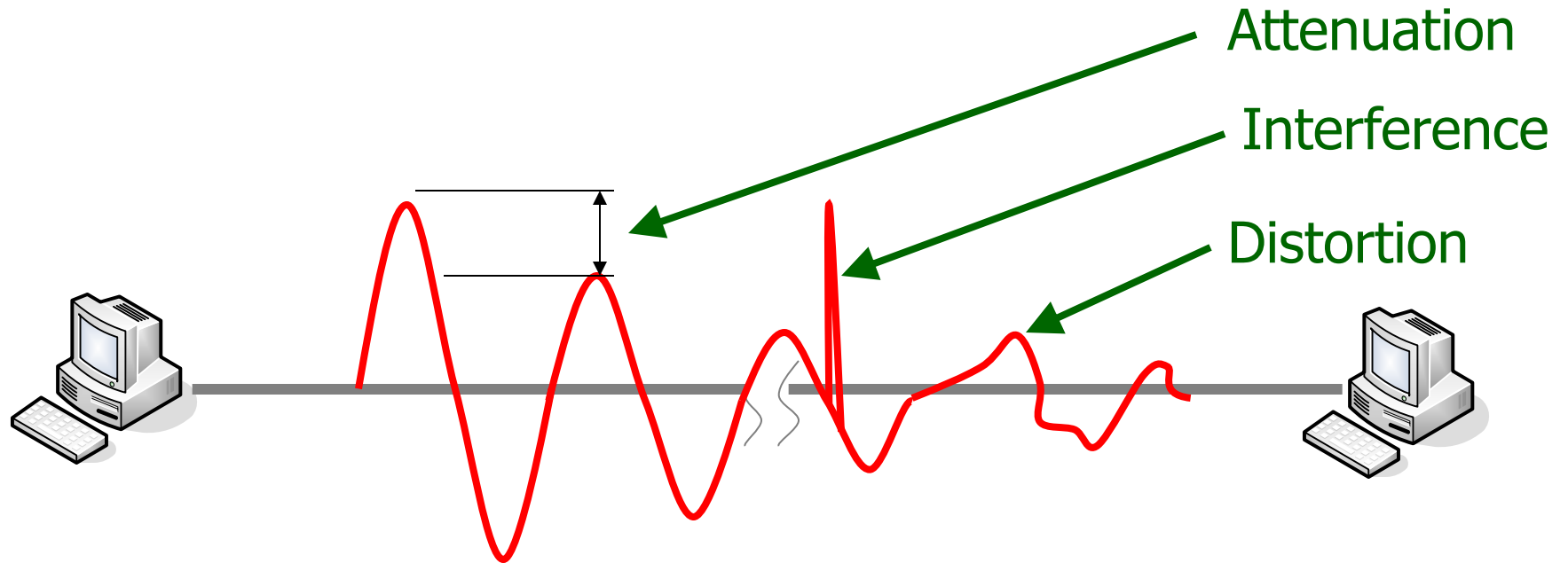

Single-bit error

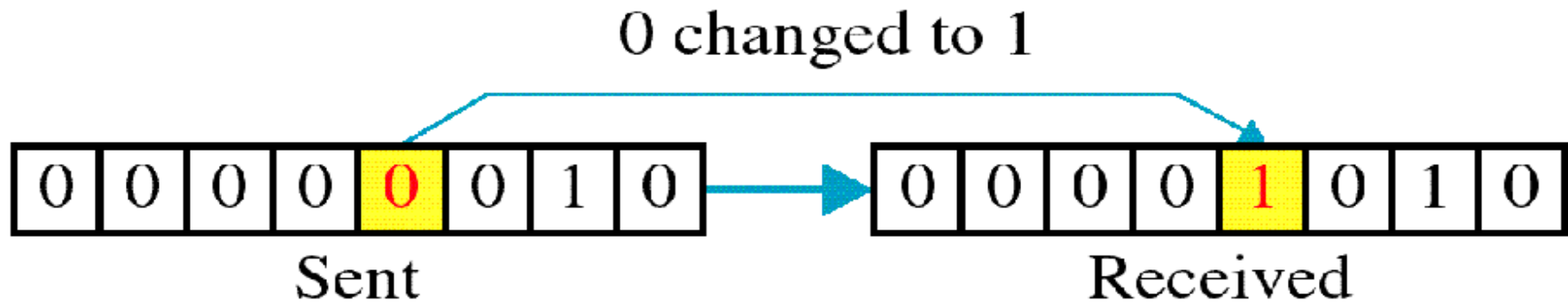

Burst error (Multiple-bit error)

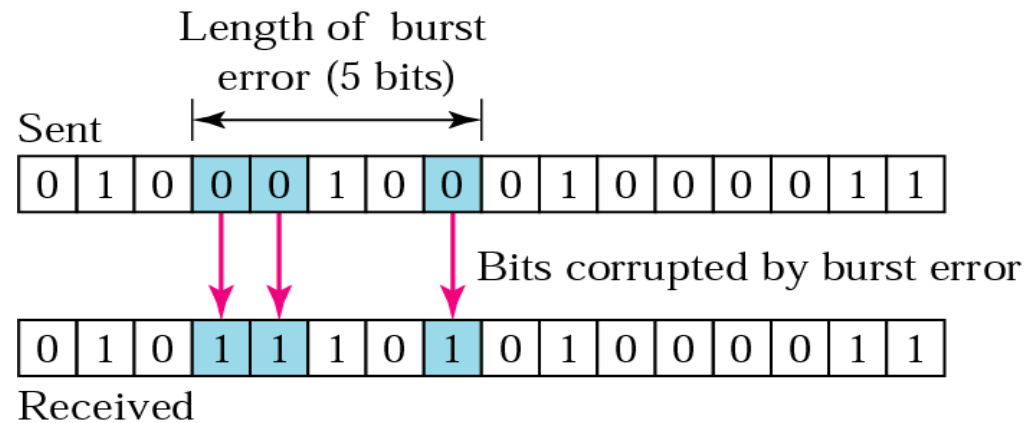
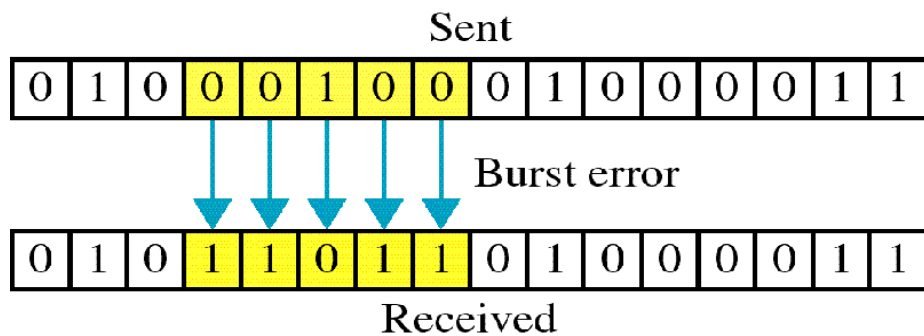
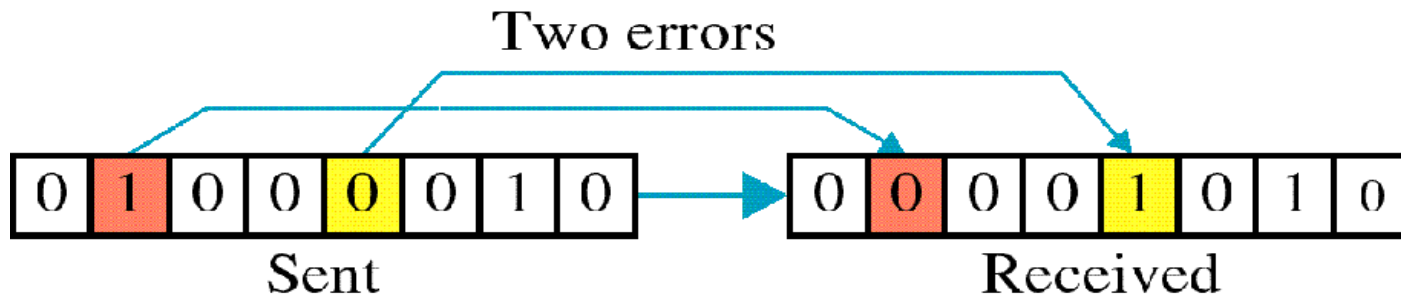



How do we know that data is corrupted (errors occur)?

- → How to detect the error?
- Does not know at the signal level
- Comparison...
- → Redundancy
 - 2 copies of everything (slow, high overhead)
 - Extra info.

Redundancy

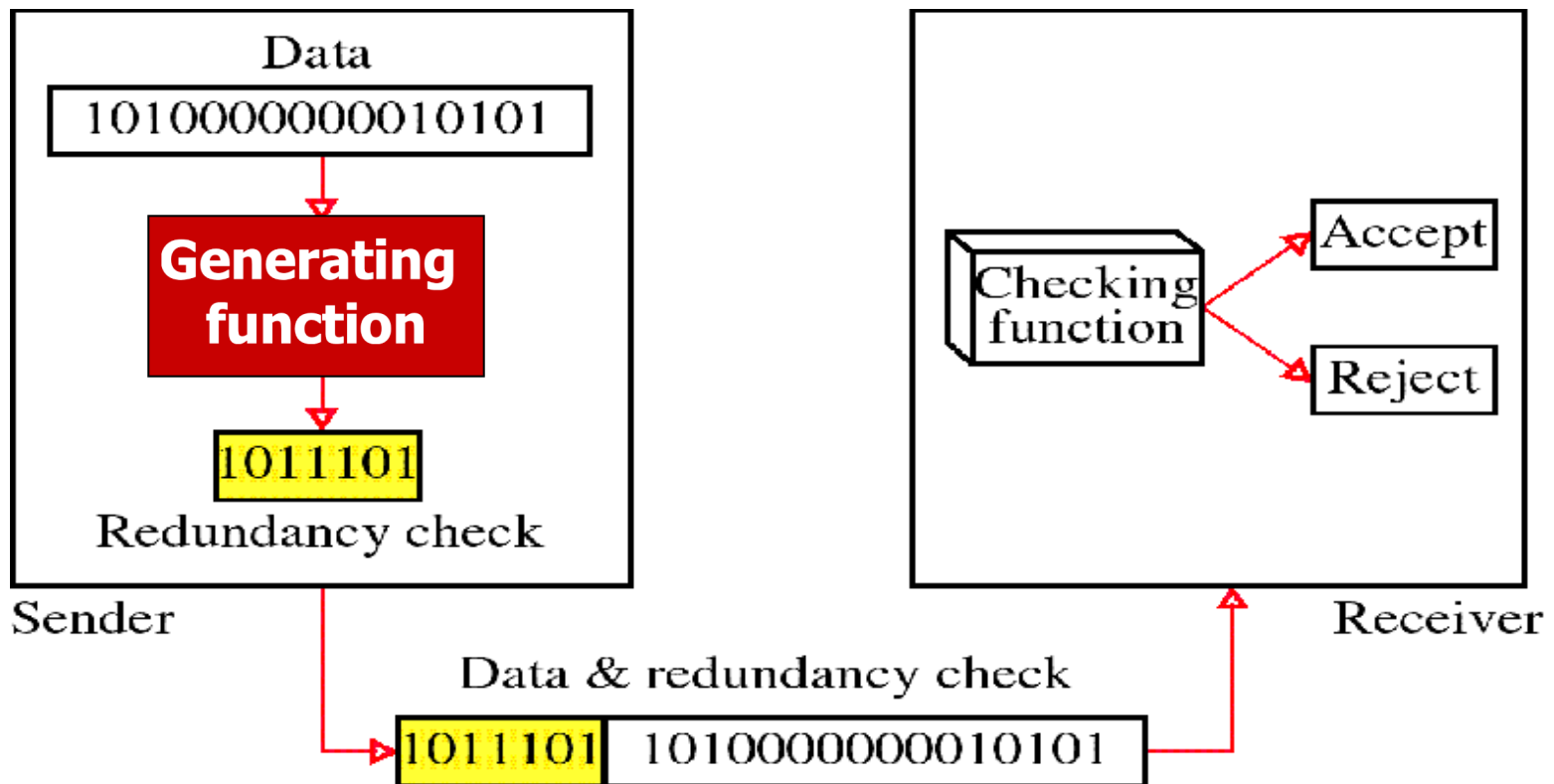

Parity Check

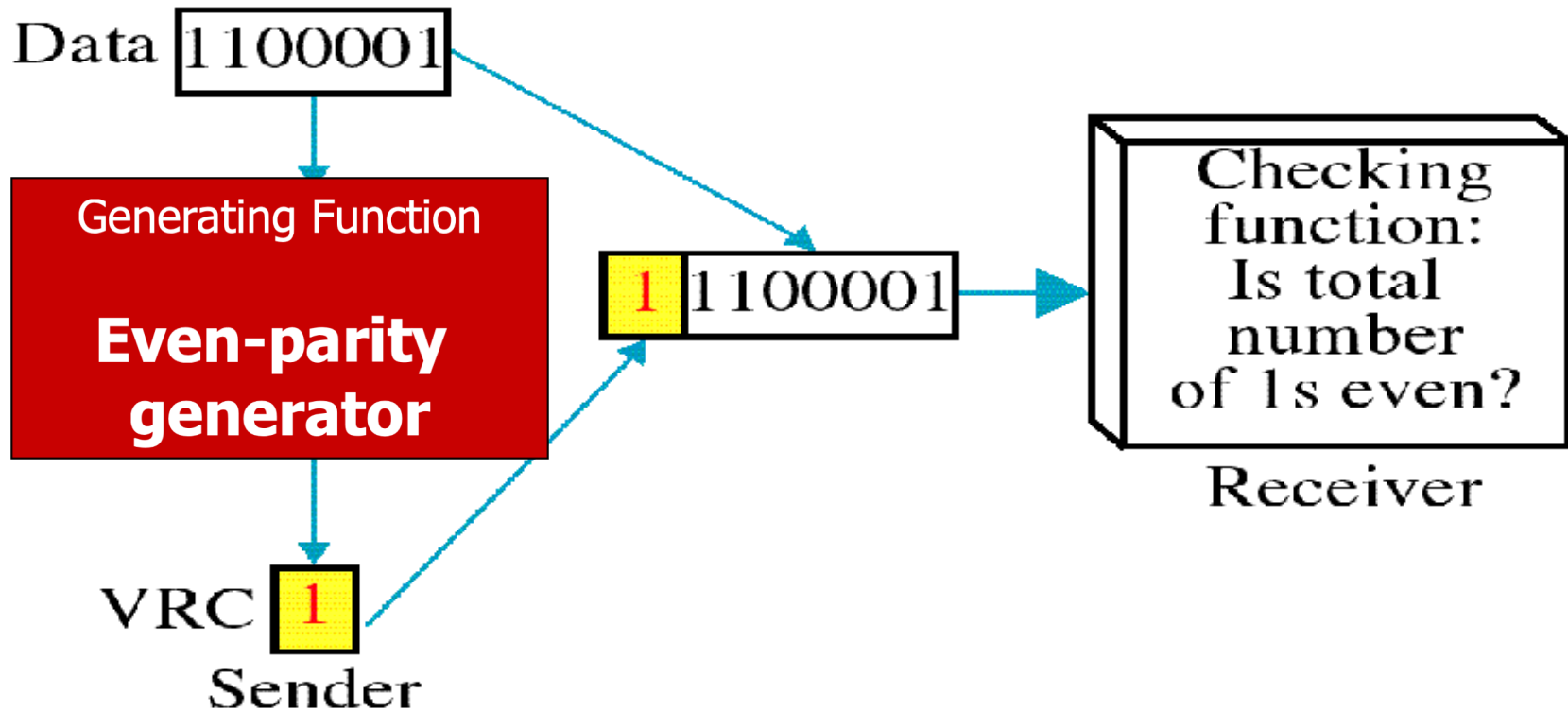



Example

Suppose the sender wants to send the word “*world*”.
In ASCII the five characters are coded as

1110111 1101111 1110010 1101100 1100100

w o r l d

The following shows the actual bits sent

11101110 11011110 11100100 11011000 11001001

Checksum

Notes:

- Segment
- Add using one's complement
- Sum is complemented

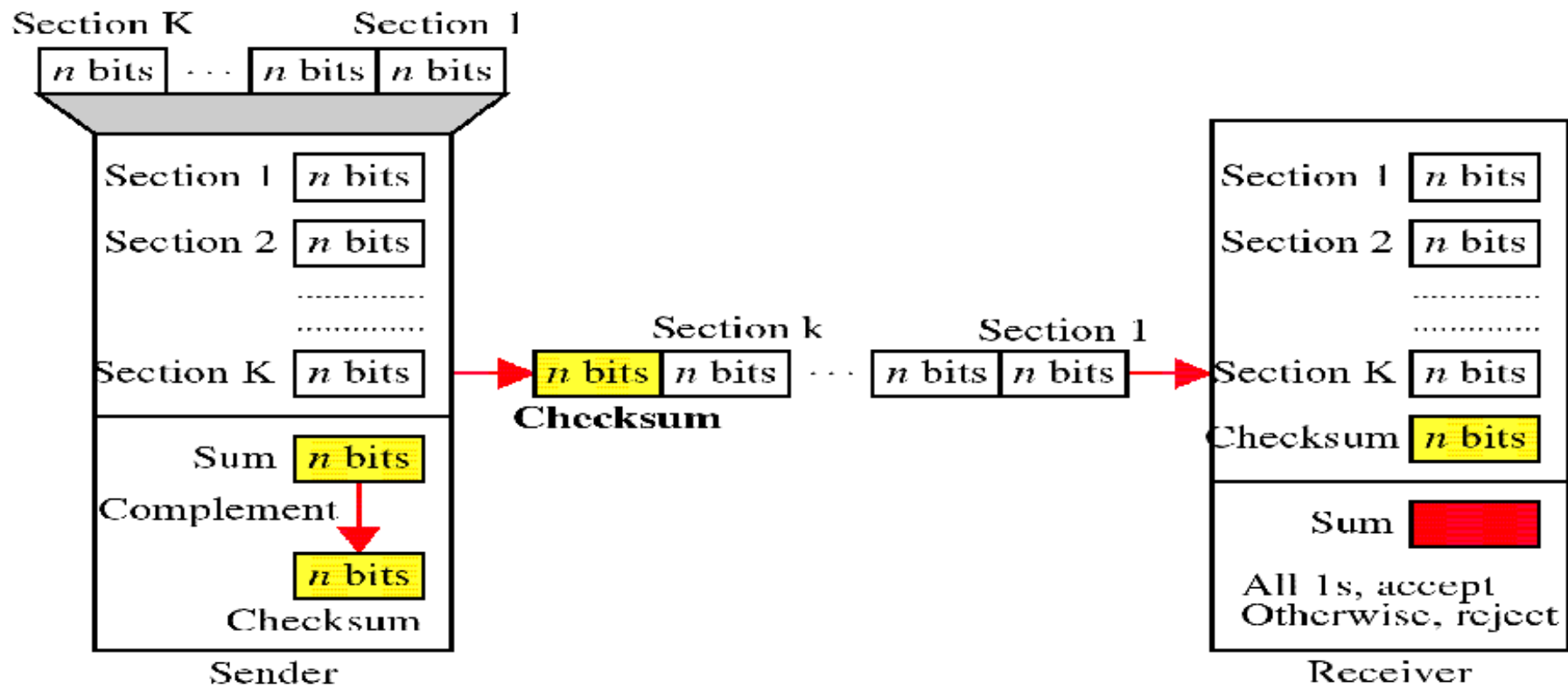



16-bit checksum example

H	e	l	l	o		w	o	r	l	d	.
48	65	6C	6C	6F	20	77	6F	72	6C	64	2E

$$4865 + 6C6C + 6F20 + 776F + 726C + 642E + \text{carry} = 71FC$$



Cannot detect (all) errors

Data Item In Binary	Checksum Value	Data Item In Binary	Checksum Value
0001	1	0011	3
0010	2	0000	0
0011	3	0001	1
0001	1	0011	3
totals	7		7

Cyclic Redundancy Check (CRC)

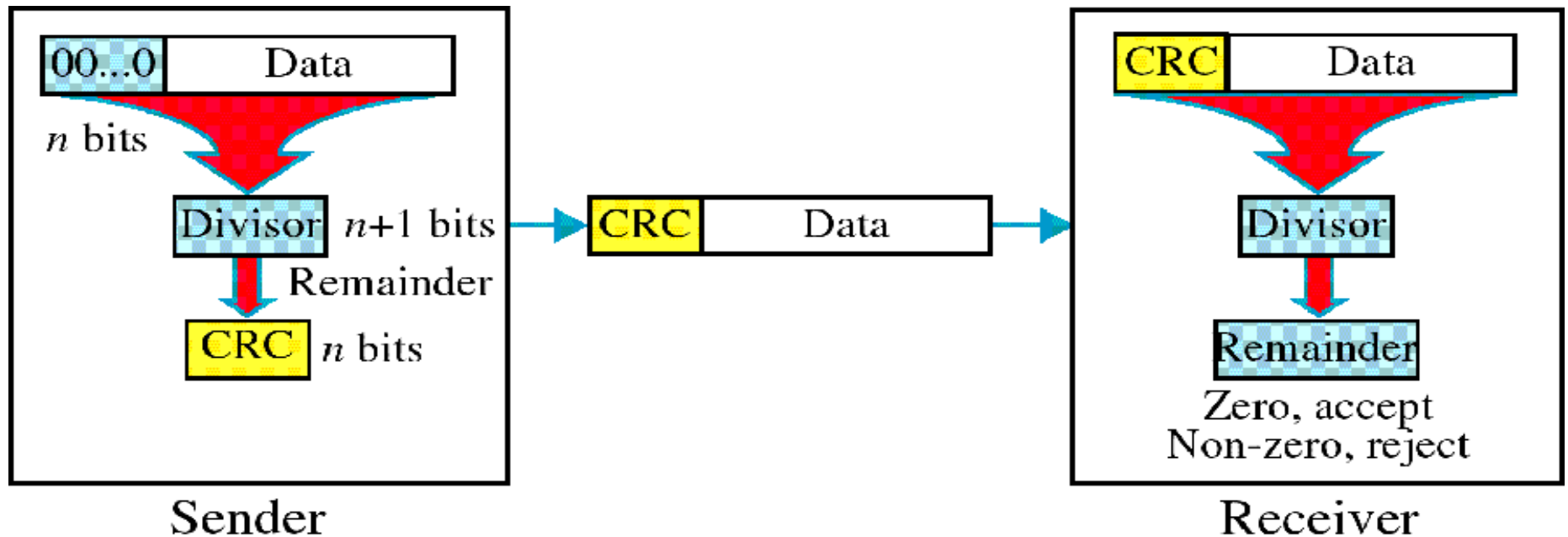

Binary Division in a CRC generator

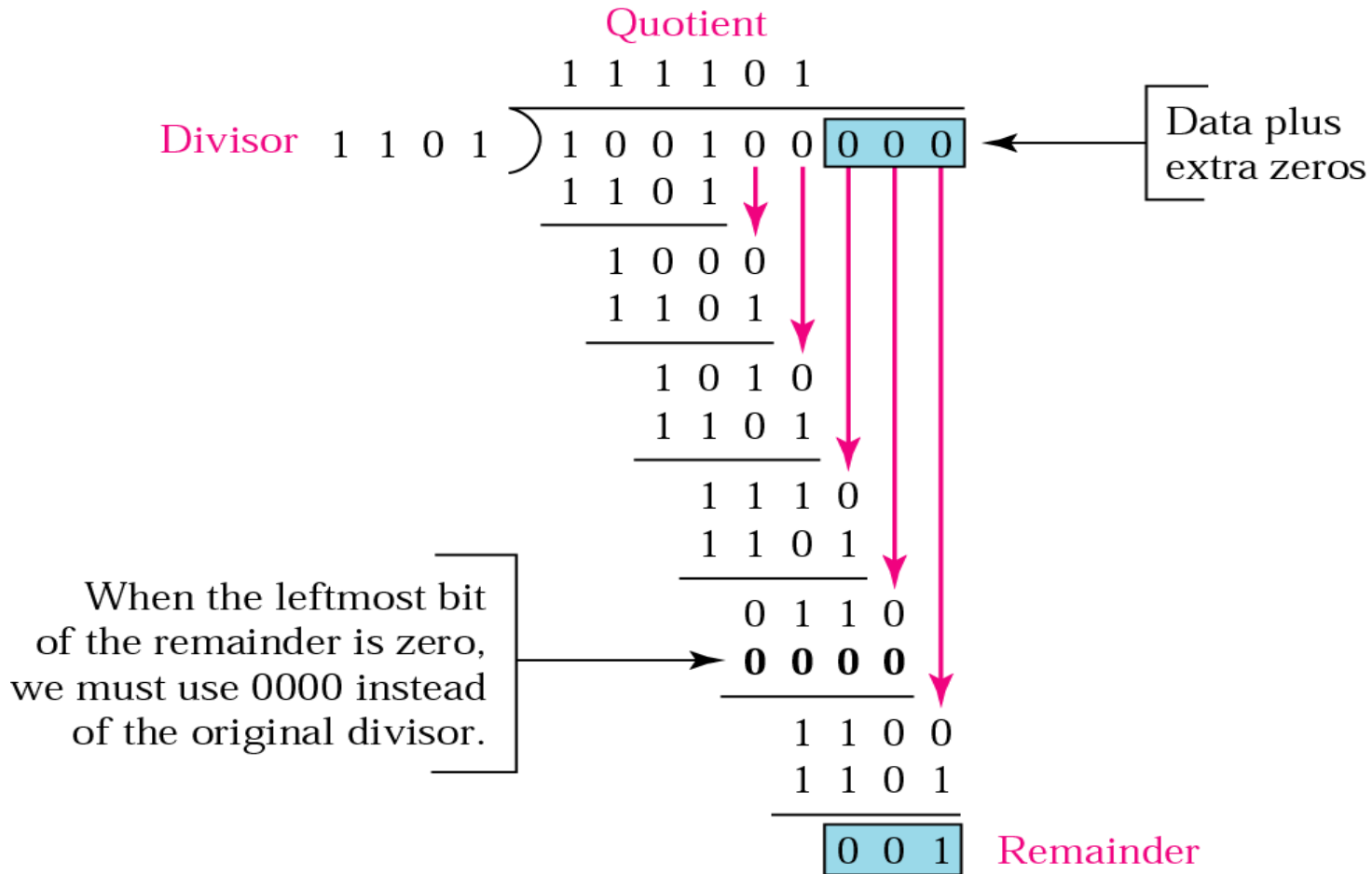

Binary Division in a CRC checker

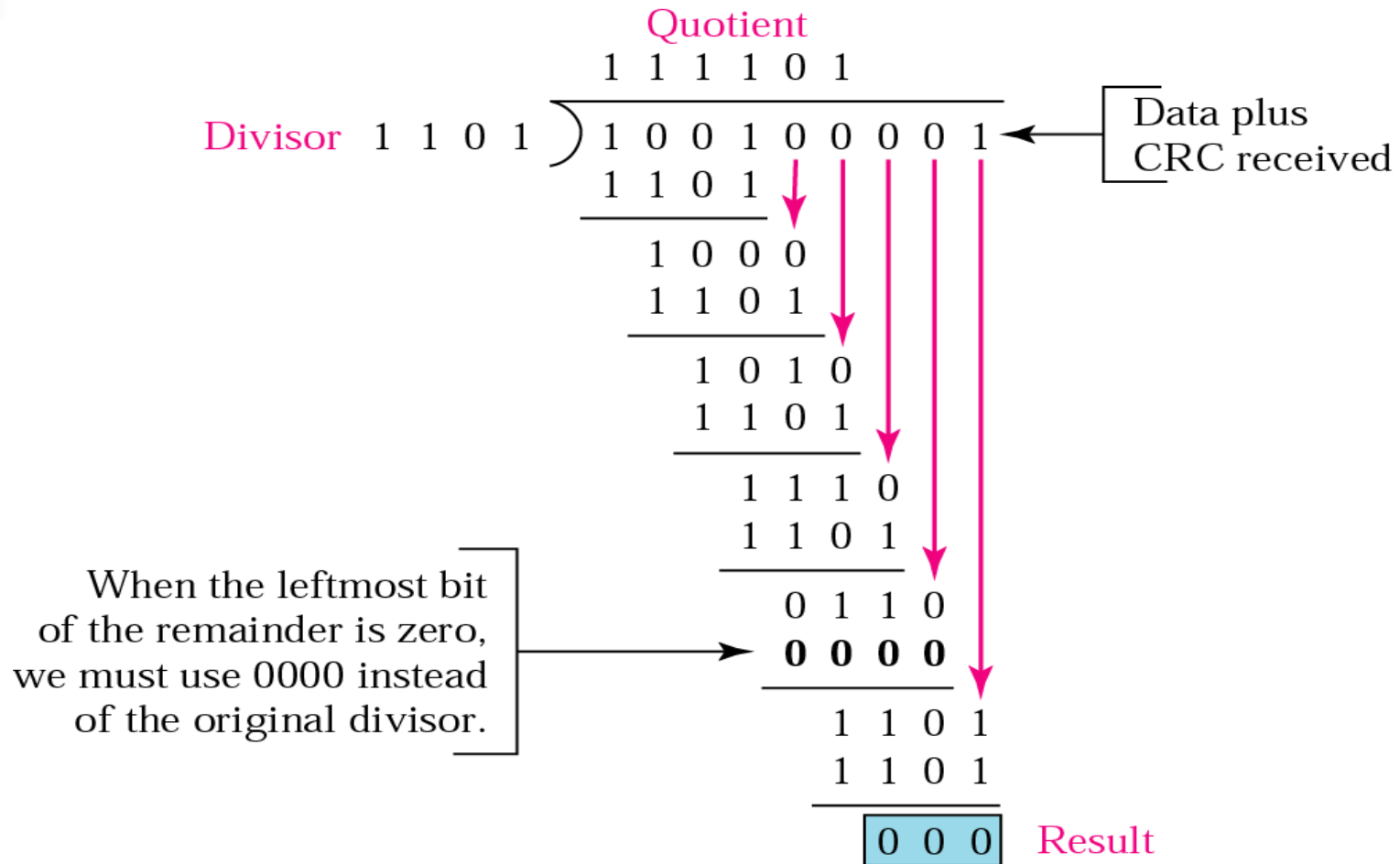



Polynomial

$$x^7 + x^5 + x^2 + x + 1$$

Polynomial and Divisor

Polynomial

$$x^7 + x^5 + x^2 + x + 1$$

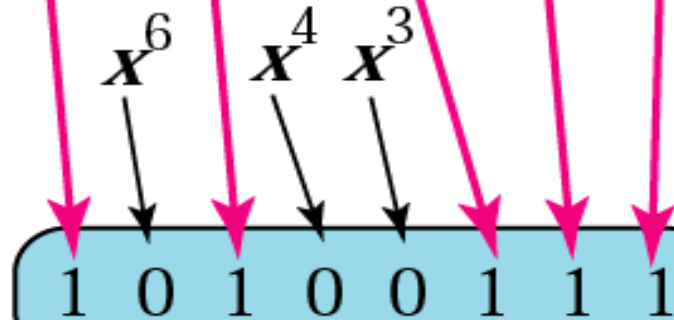

Divisor



Choosing the polynomial

2 properties

- Should not be divisible by x
- Should be divisible by $(x+1)$

Example

- Cannot choose x (binary 10) or $x^2 + x$ (binary 110)
 - Because both are divisible by x .
- Can choose $x + 1$ (binary 11)
 - Because it is not divisible by x , but is divisible by $x + 1$.
- Also choose $x^3 + x^2 + 1$ (binary 1101)
 - Because it is divisible by $x + 1$ (binary division).

Standard Polynomials

Name	Polynomial	Application
CRC-8	$x^8 + x^2 + x + 1$	ATM header
CRC-10	$x^{10} + x^9 + x^5 + x^4 + x^2 + 1$	ATM AAL
ITU-16	$x^{16} + x^{12} + x^5 + 1$	HDLC
ITU-32	$x^{32} + x^{26} + x^{23} + x^{22} + x^{16} + x^{12} + x^{11} + x^{10} + x^8 + x^7 + x^5 + x^4 + x^2 + x + 1$	LANs



CRC

- Very effective detection method
- Can detect all burst of length $<$ degree of polynomial
- Detect other errors \rightarrow high prob.

CRC implementation

Ex-OR

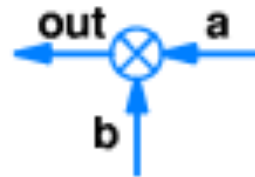

(a)

a	b	out
0	0	0
0	1	1
1	0	1
1	1	0

(b)

Shift Register

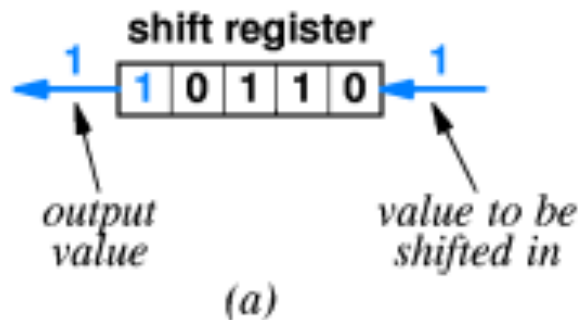

(a)

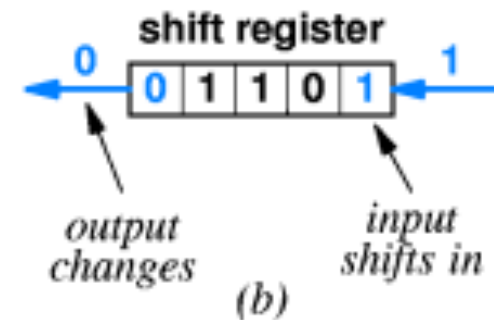

(b)

16-bit CRC Hardware Implementation

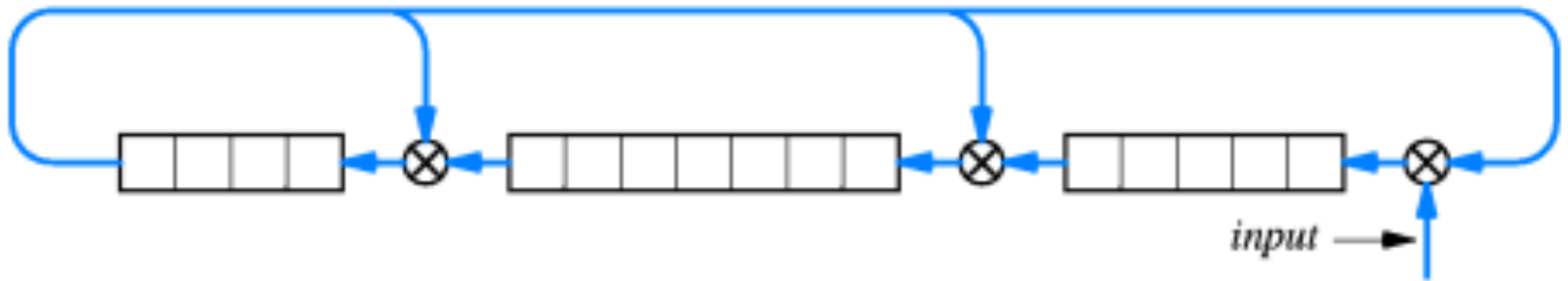



Data Frame





Summary

- Transmission Errors
- Error Detection Mechanism
 - Parity
 - Checksum
 - CRC