



Long-Distance Communication

รศ.ดร. อนันต์ พลเพิ่ม

Asso. Prof. Anan Phonphoem, Ph.D.

anan.p@ku.ac.th

<http://www.cpe.ku.ac.th/~anan>

Computer Engineering Department

Kasetsart University, Bangkok, Thailand



Outline

- Long-distance problem
- Carrier
- Modulation
- Modem
- Multiplexing
- Spread Spectrum

Long-Distance Communication

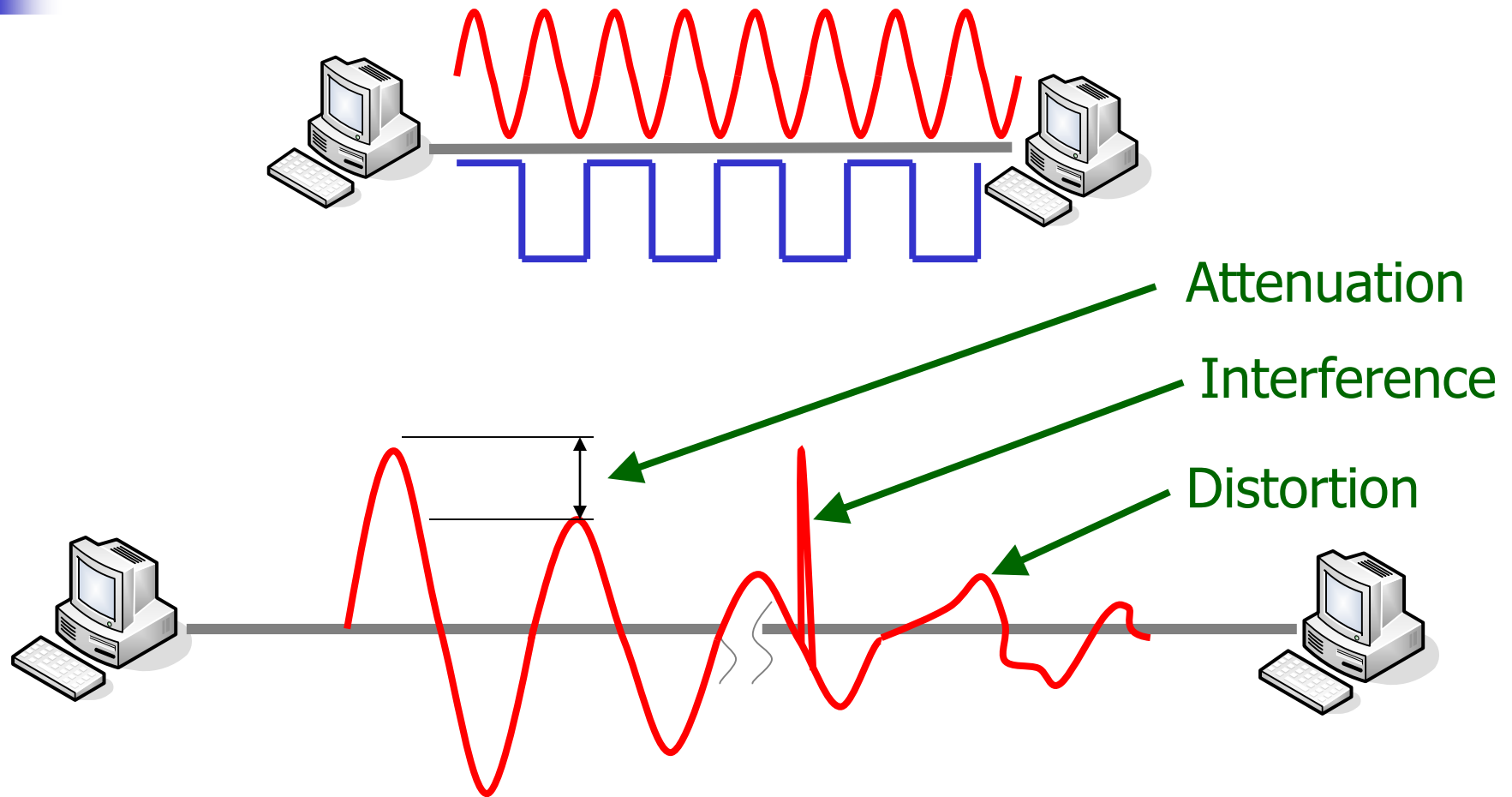



Basic concepts

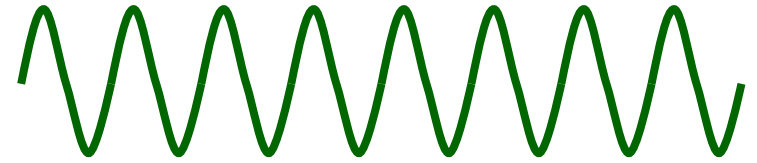

- **Carrier signal (carrier frequency)**
 - High frequency as a basis for information
 - Sender and receiver agree on the frequency
 - Digital data is modulated (shift keying) on the carrier by modifying carrier characteristics
- **3 characteristics of carrier signal**
 - Amplitude
 - Frequency
 - Phase

Amplitude Change

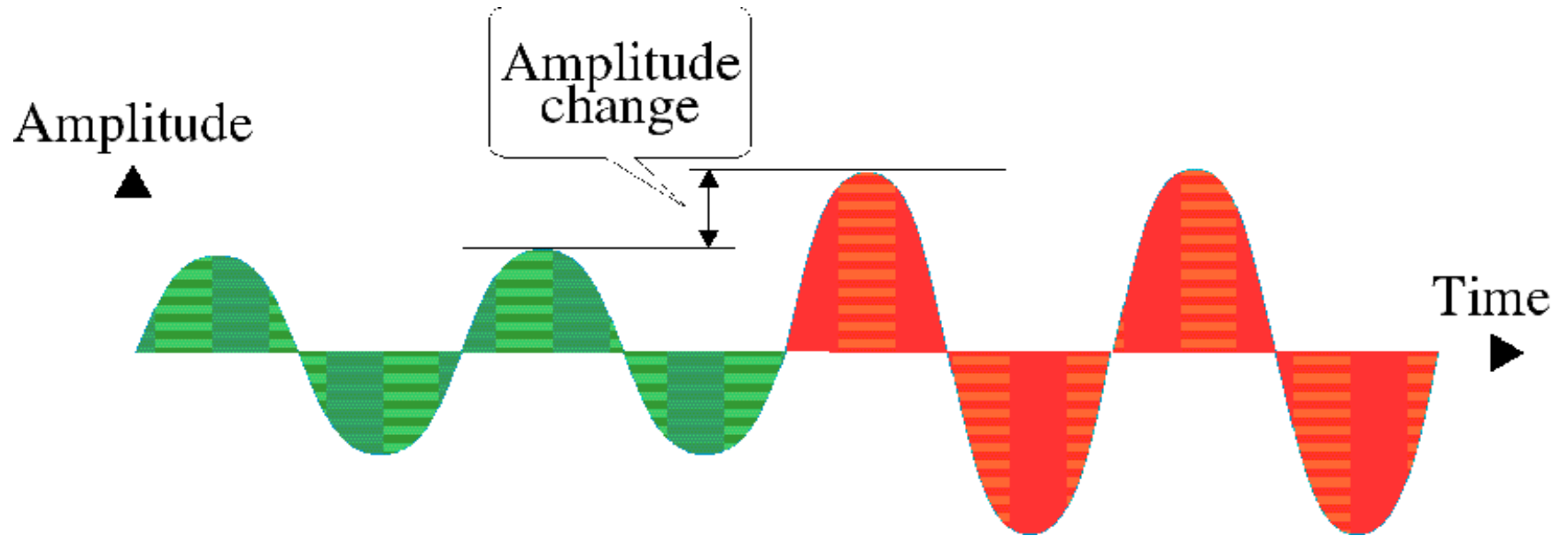



Frequency Change

Amplitude

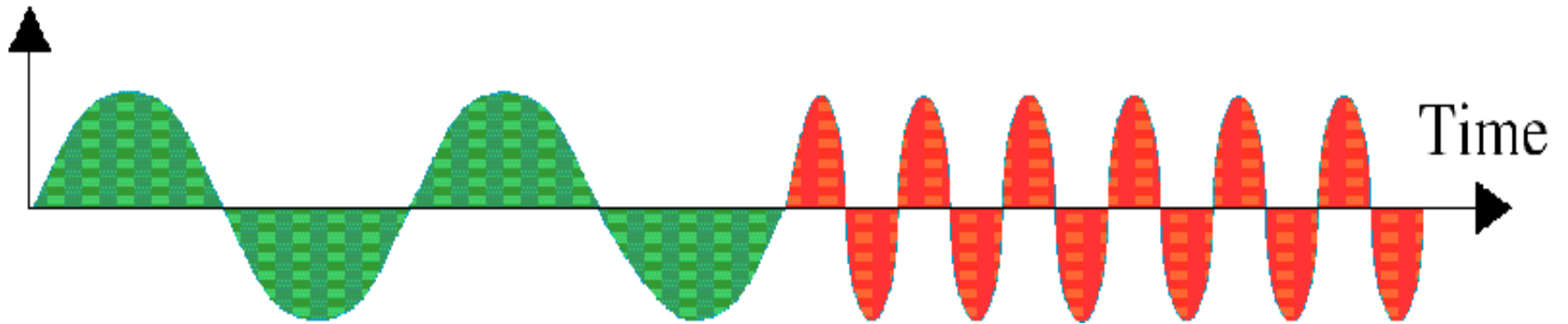

Phase Change

Amplitude

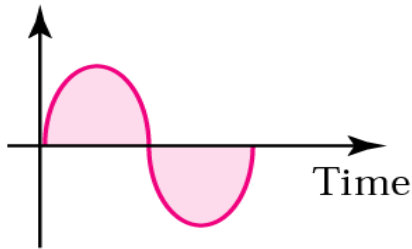

a. 0°

Amplitude

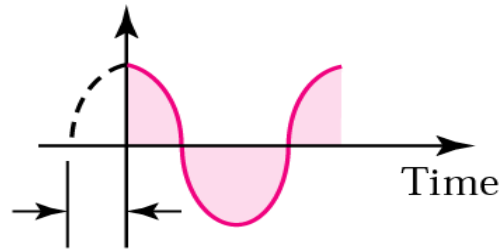

b. 90°

Amplitude

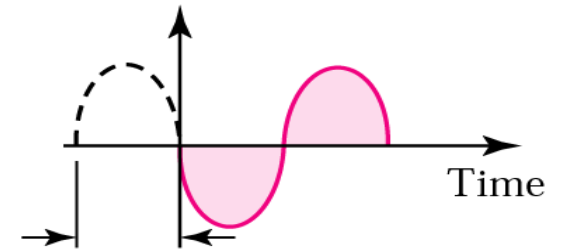

c. 180°



a. No phase change

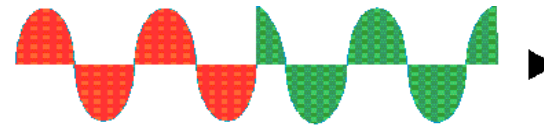

b. 90 degree phase change



c. 180 degree phase change

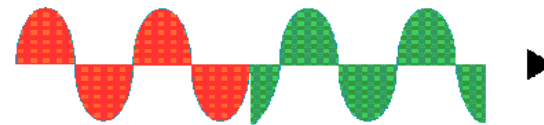

d. 270 degree phase change

Amplitude Modulation

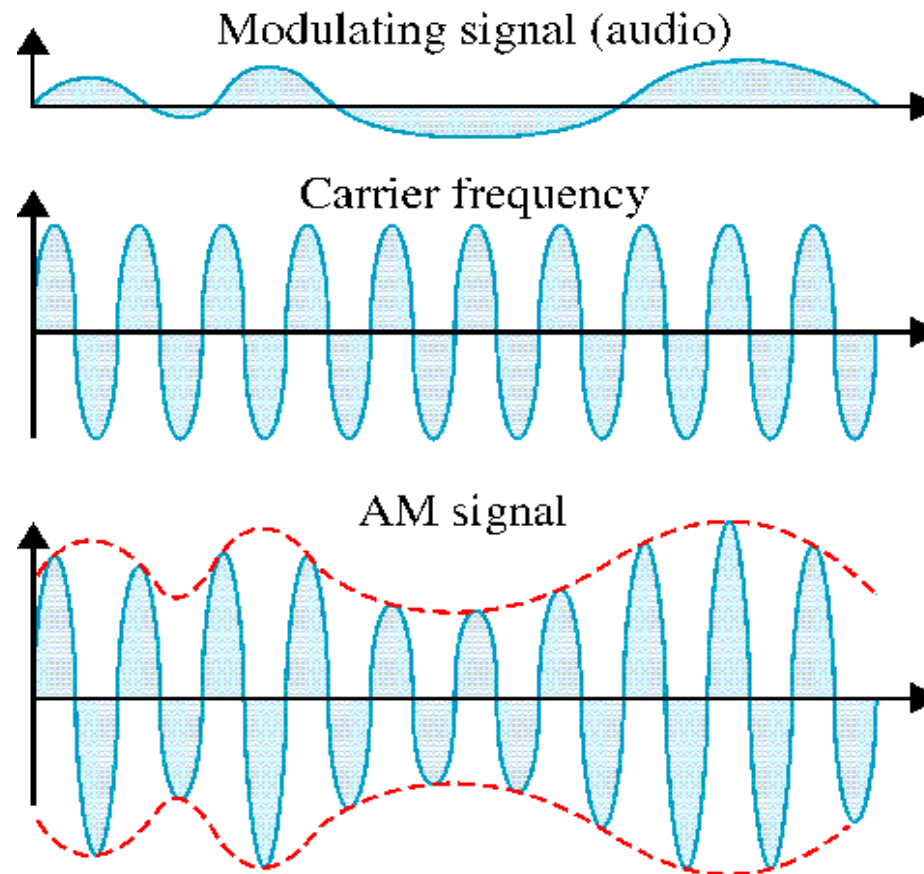

Frequency Modulation

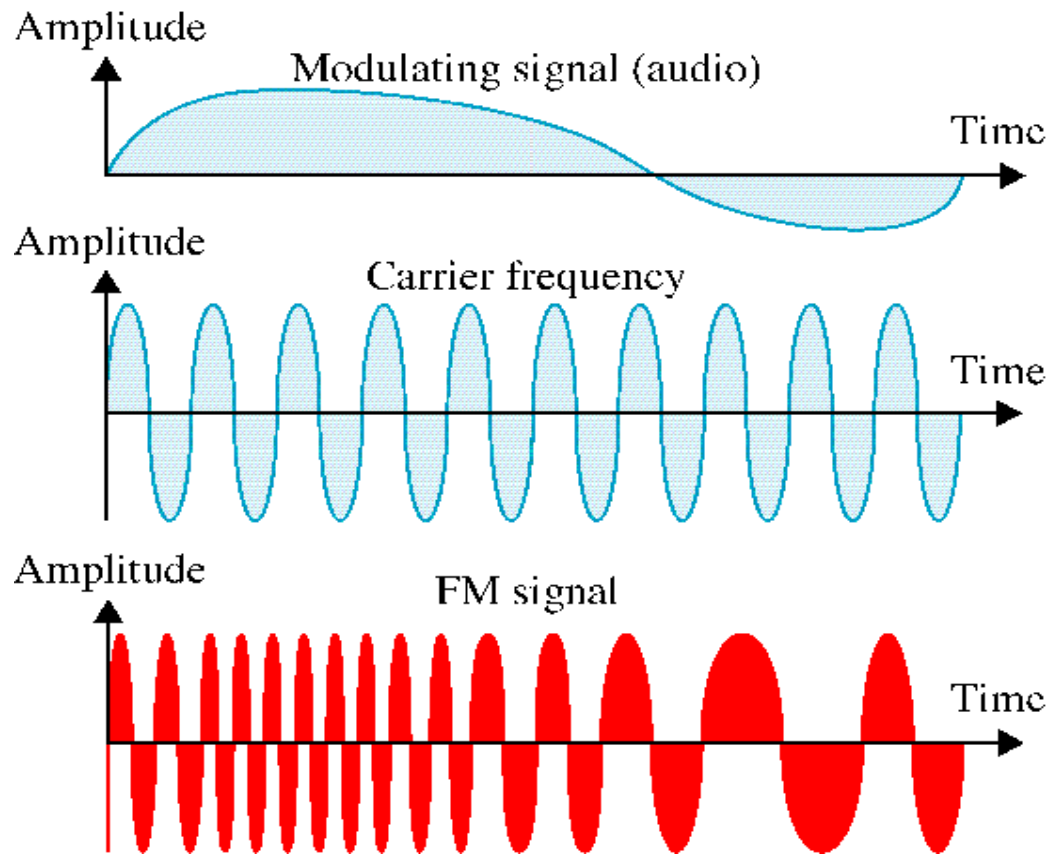

Amplitude Shift Keying (ASK)

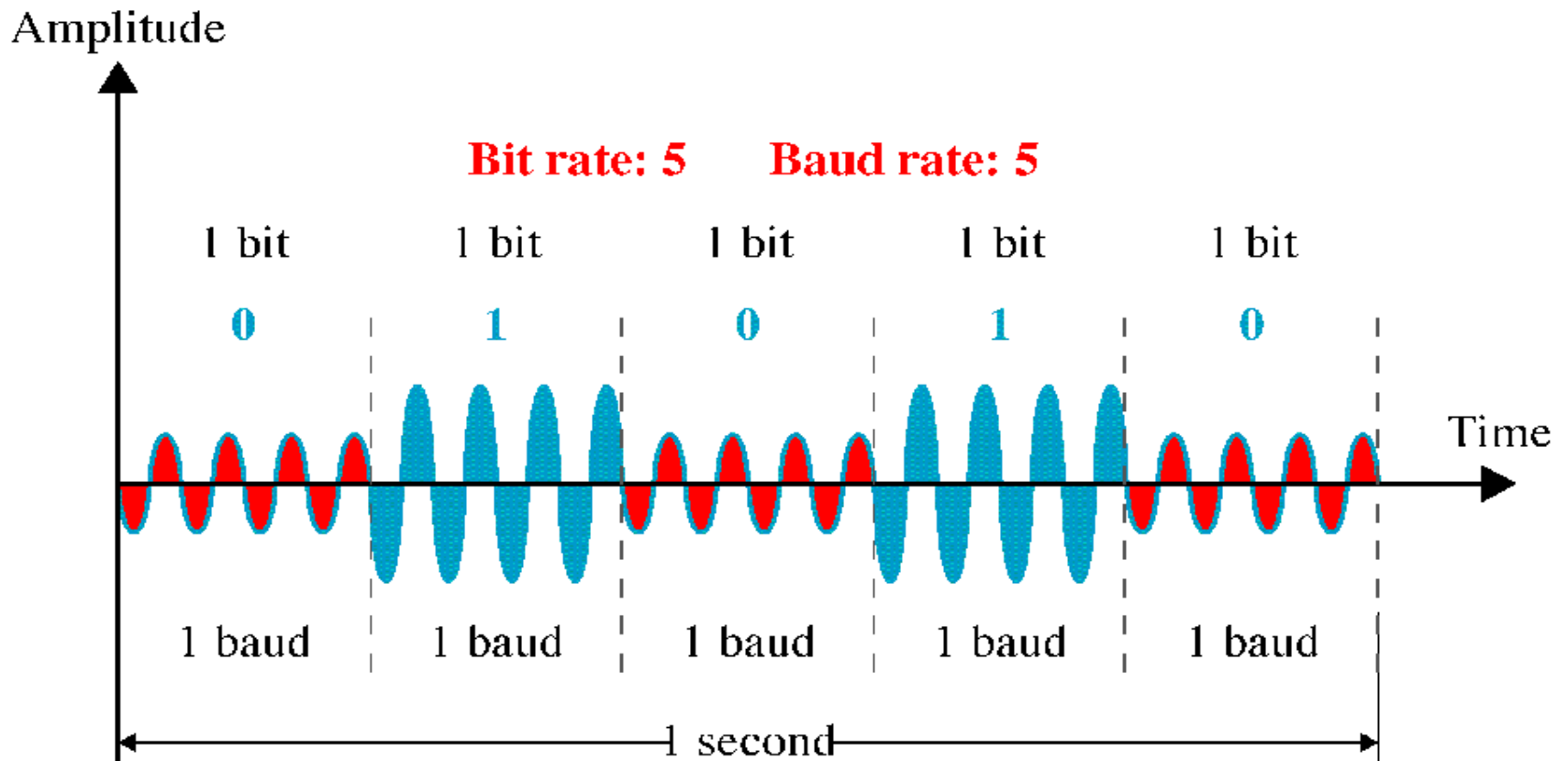

Frequency Shift Keying (FSK)

Amplitude

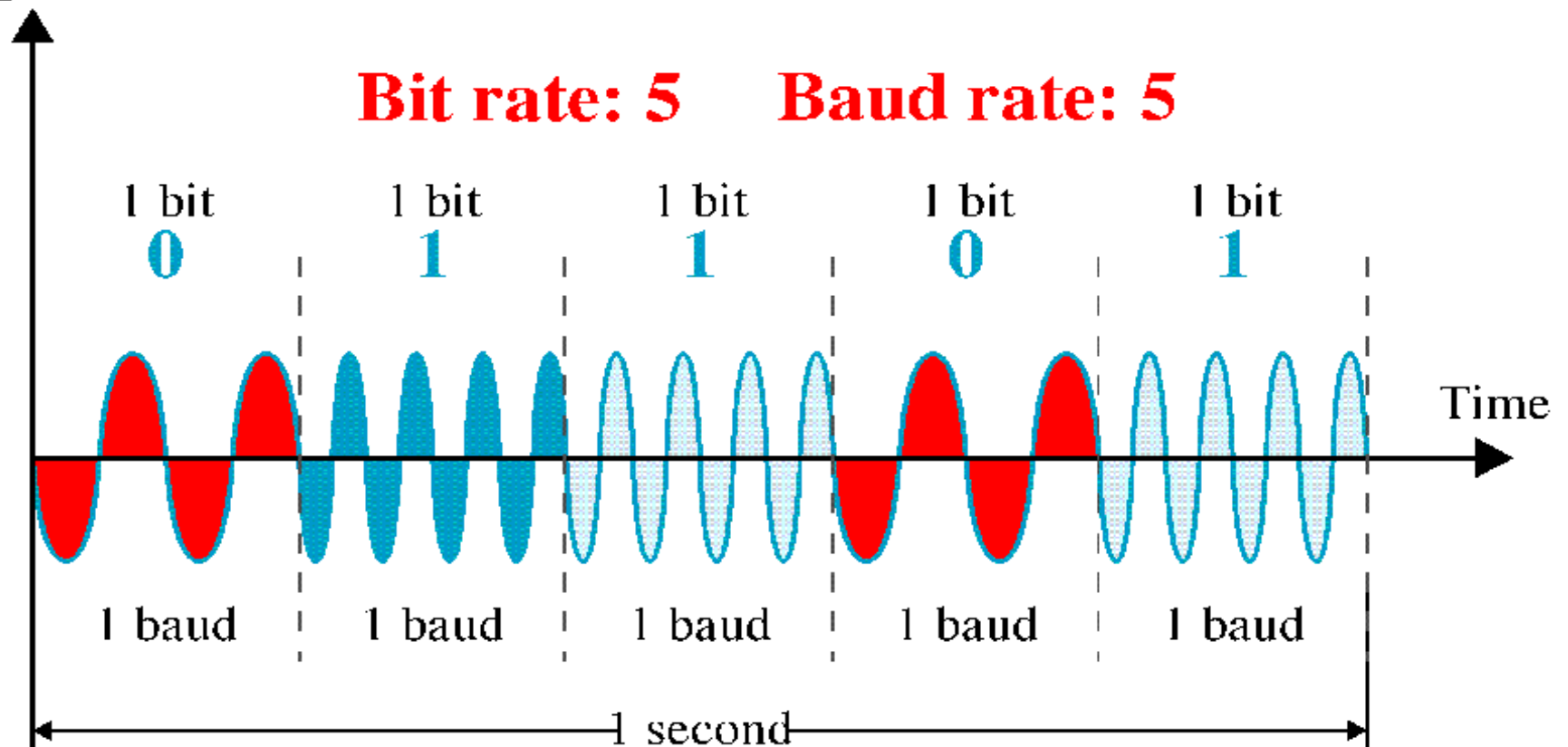

Phase Shift Keying (PSK)

Amplitude

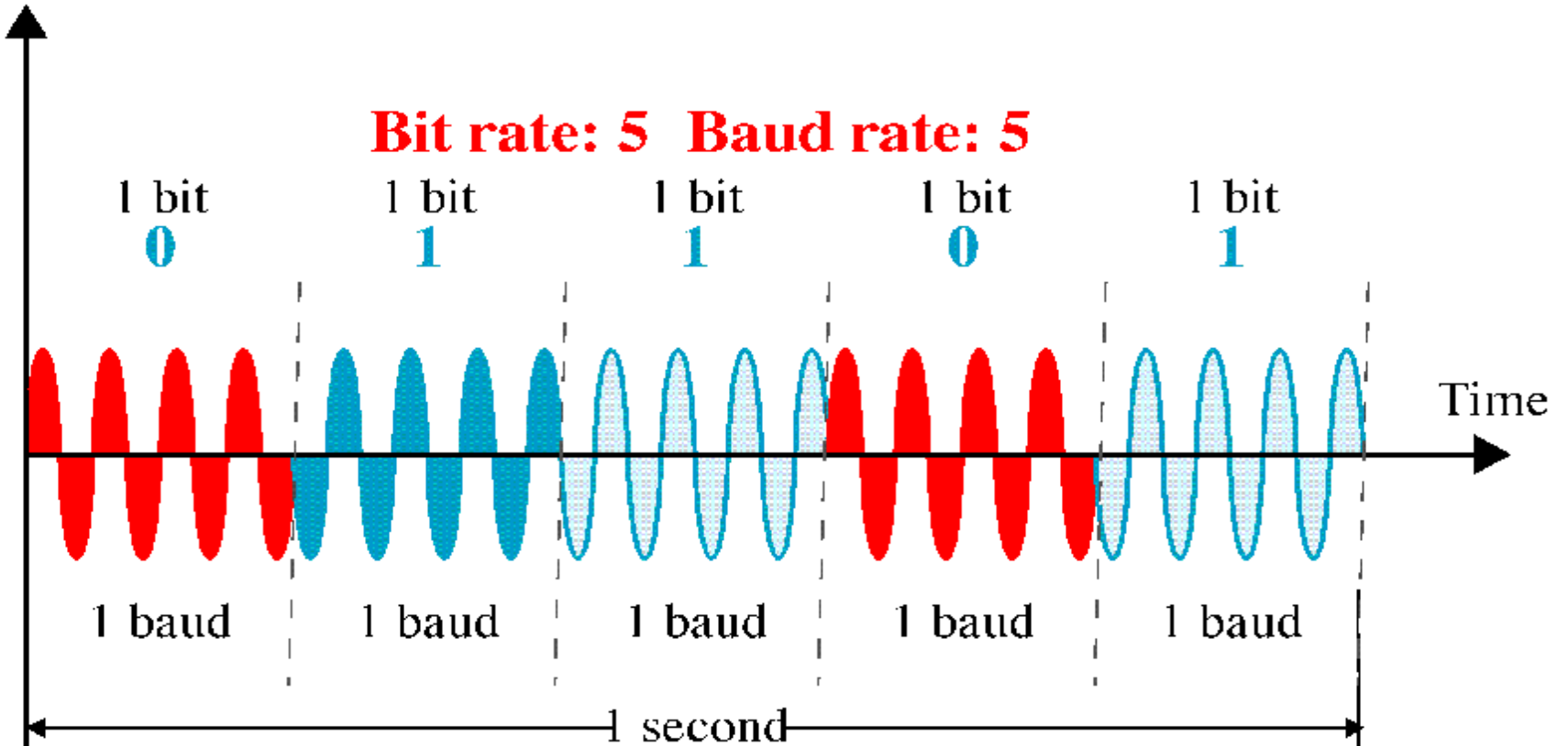

Modem

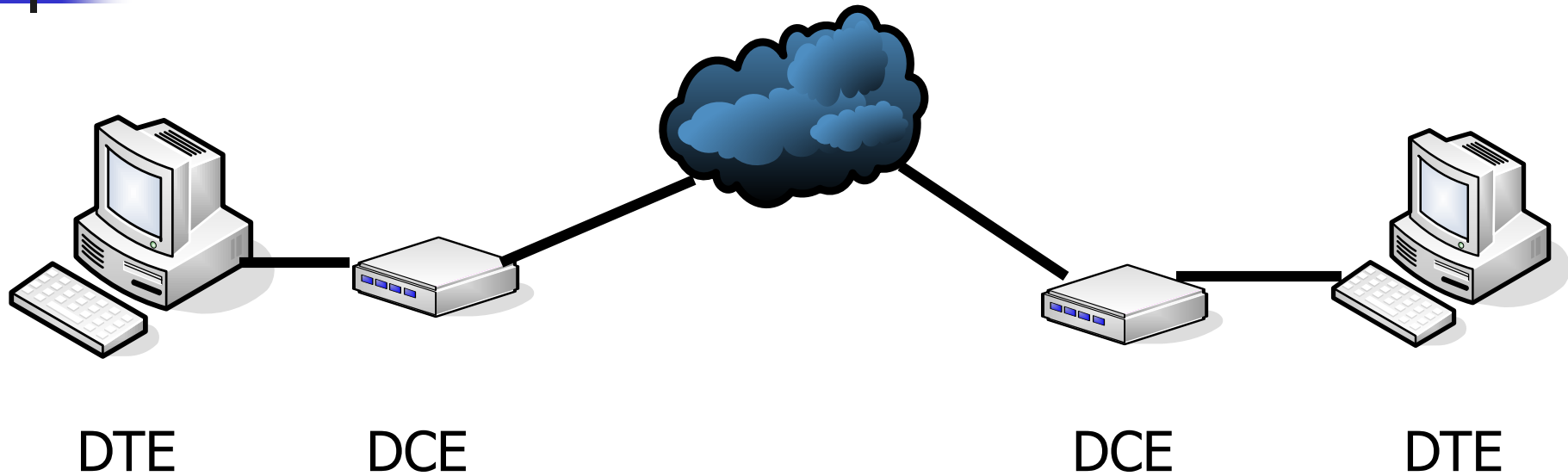

Convert digital signal \leftrightarrow analog signal
Modulation and **dem**odulation

Modem concept

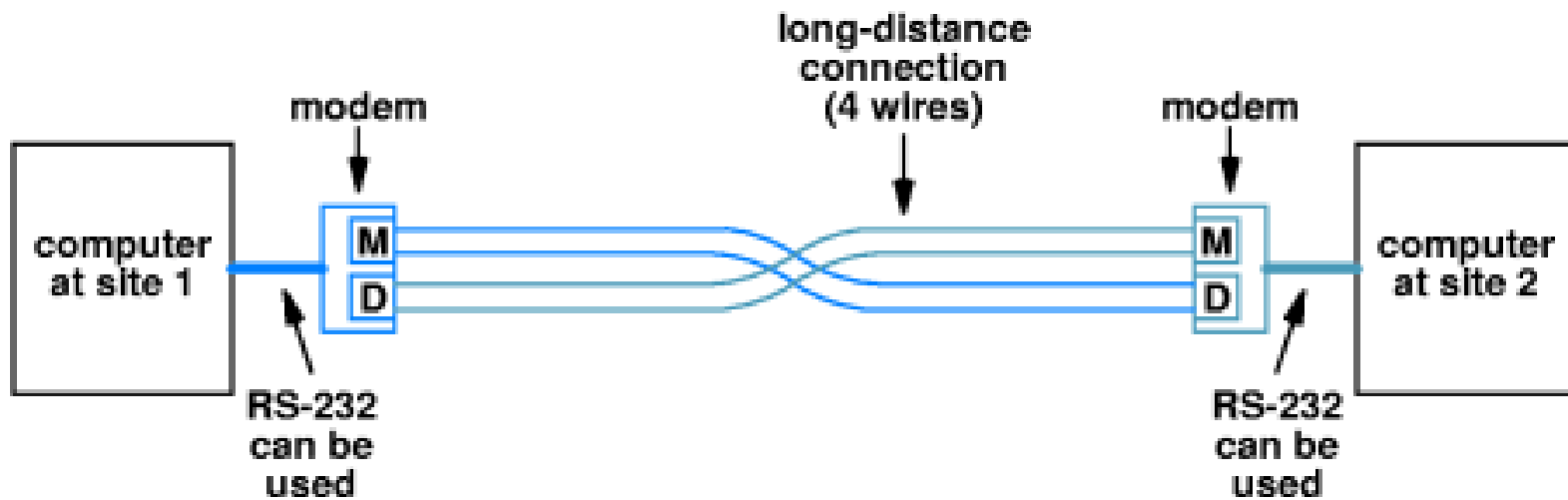

Modem concept

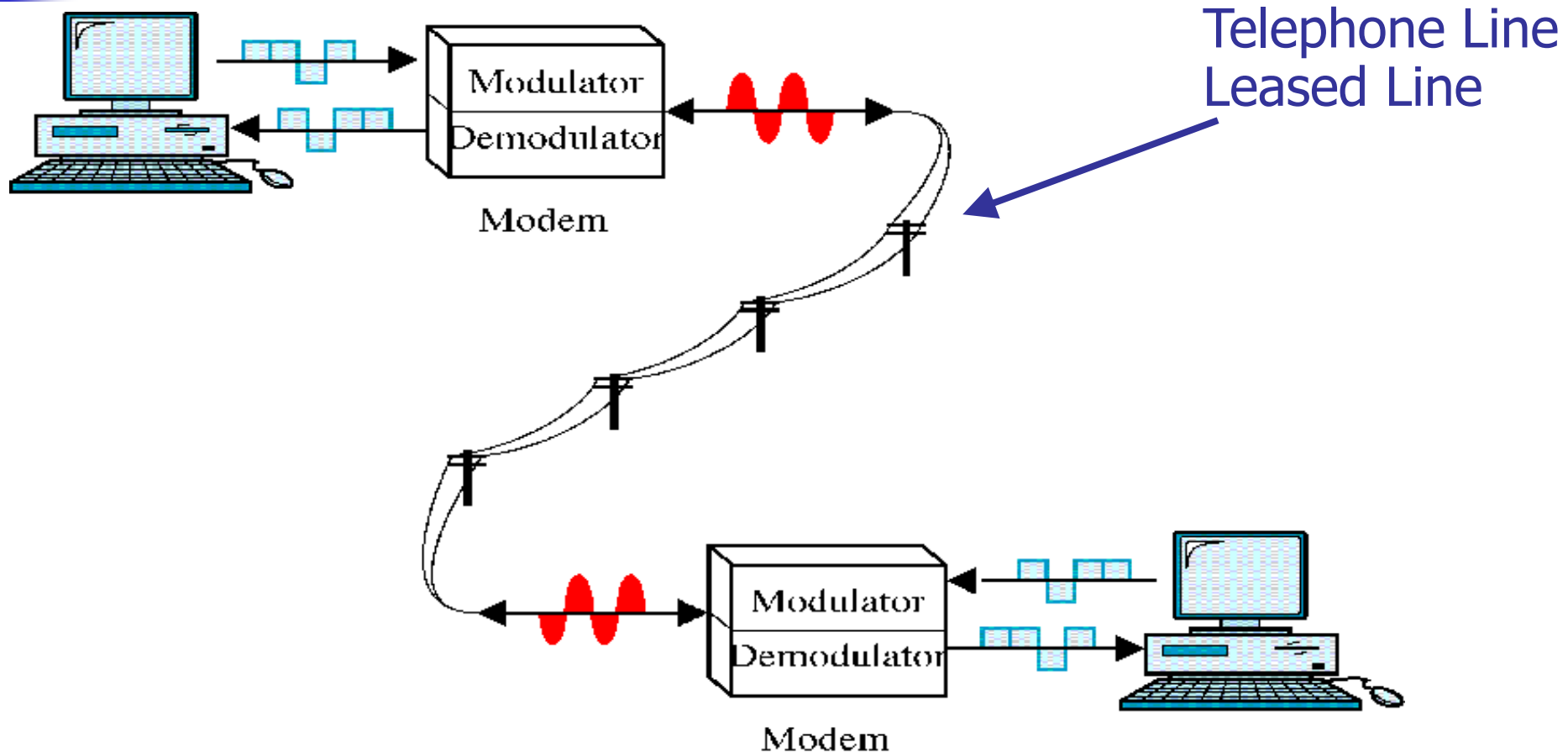



Modem concept

- Modulator
 - Convert digital signal → analog signal
 - Modulation technique (ASK,FSK,PSK,QAM)
- Demodulator
 - A reverse process of modulation → not a converter
 - No signal sampling



Modem data rate (bit rate)

- 14.4 Kbps, 33.6 Kbps, 56 Kbps
- Depends upon
 1. Medium bandwidth
 2. Data encoding



Why multiplexing?

- Media Sharing
 - Medium Transmission Capacity
 - High bandwidth media (coax, optical fiber)
- Cost-effective
- Medium Transmission Cap $>$ data rate required

Terms:

- Path
- Channel

Multiplexing vs. No Multiplexing

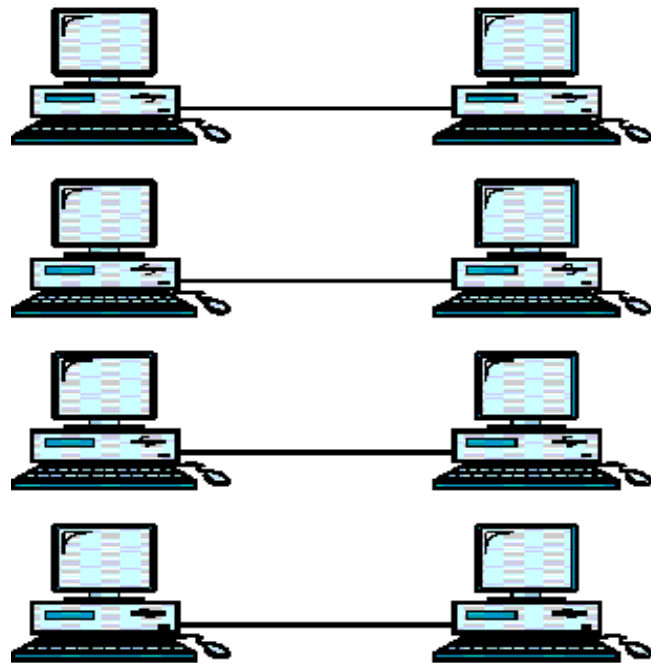

a. No multiplexing

Many to One

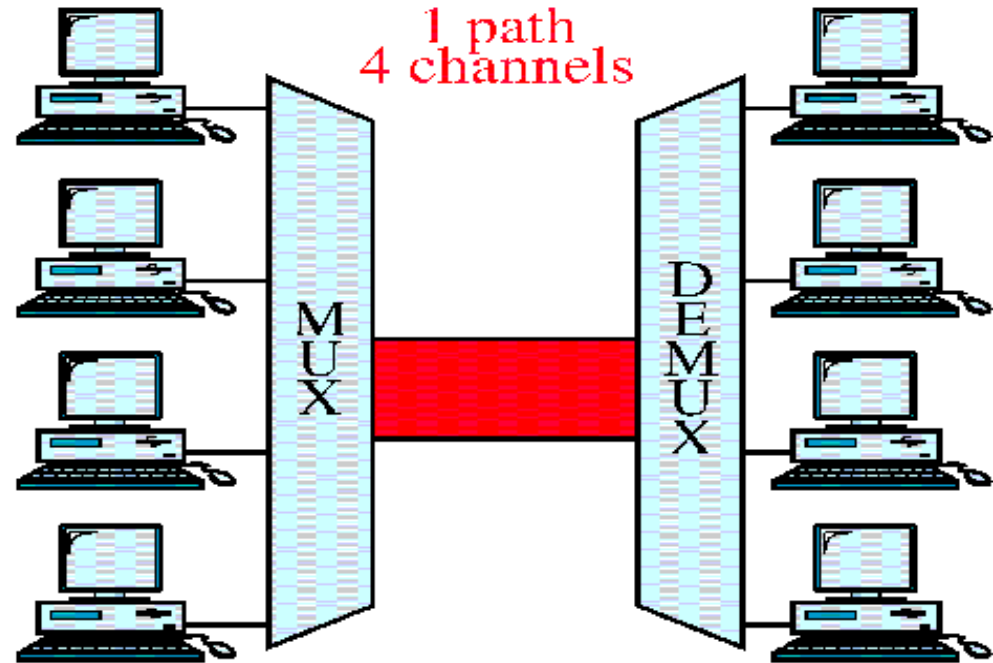

One to Many

b. Multiplexing

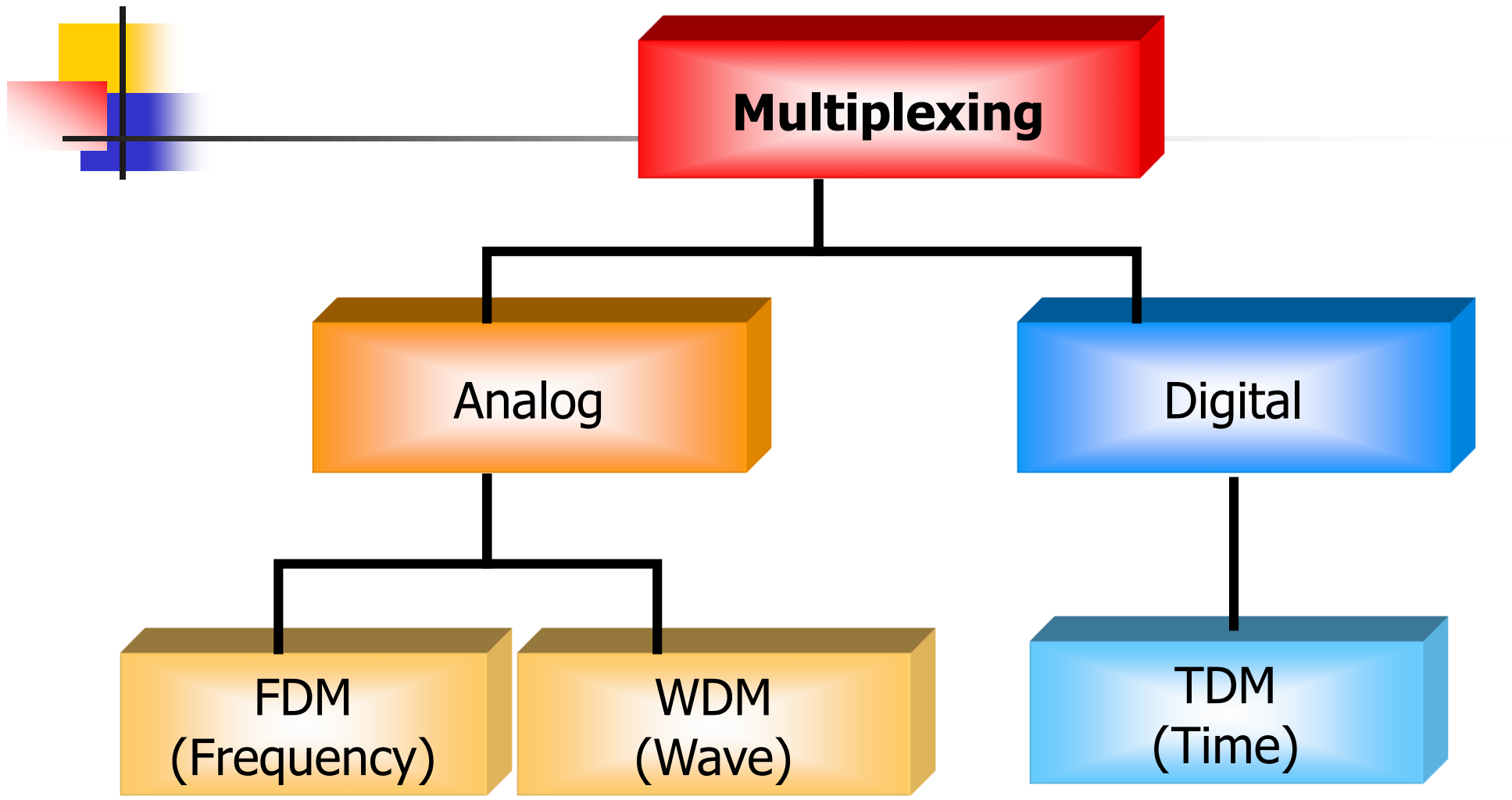

FDM, Time Domain

Using AM or FM

Multiplexer

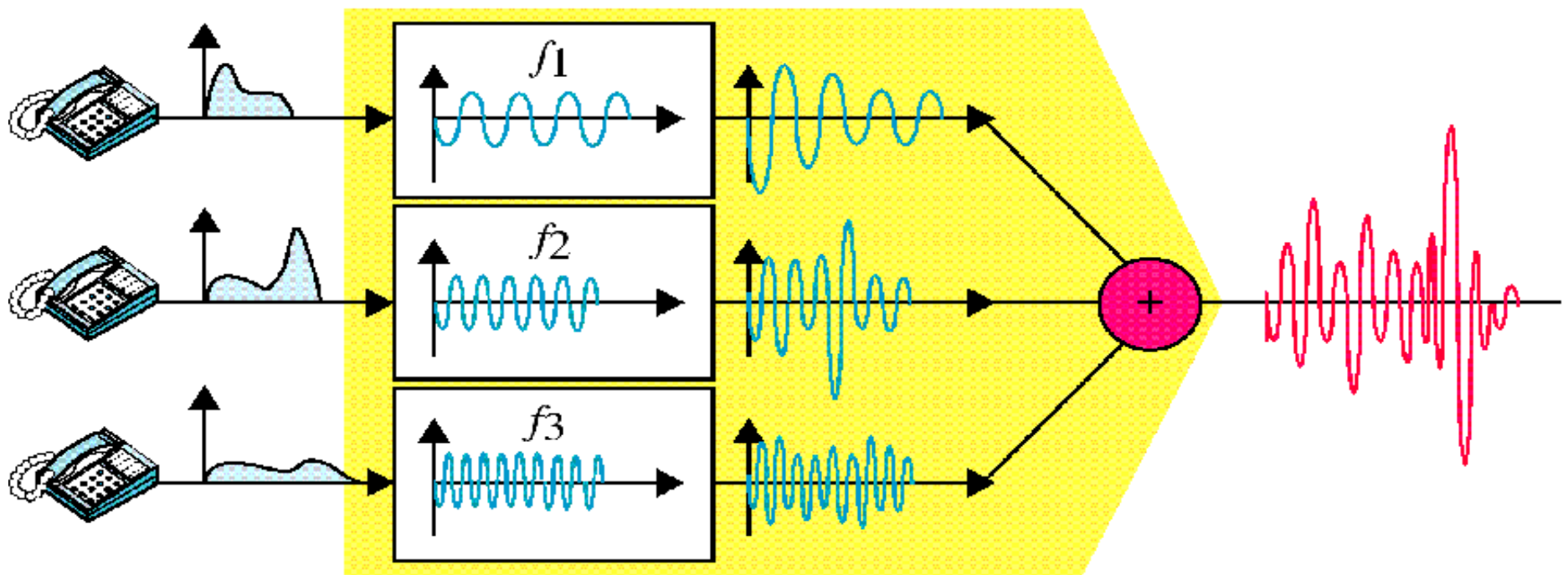

Multiplexing, Frequency Domain

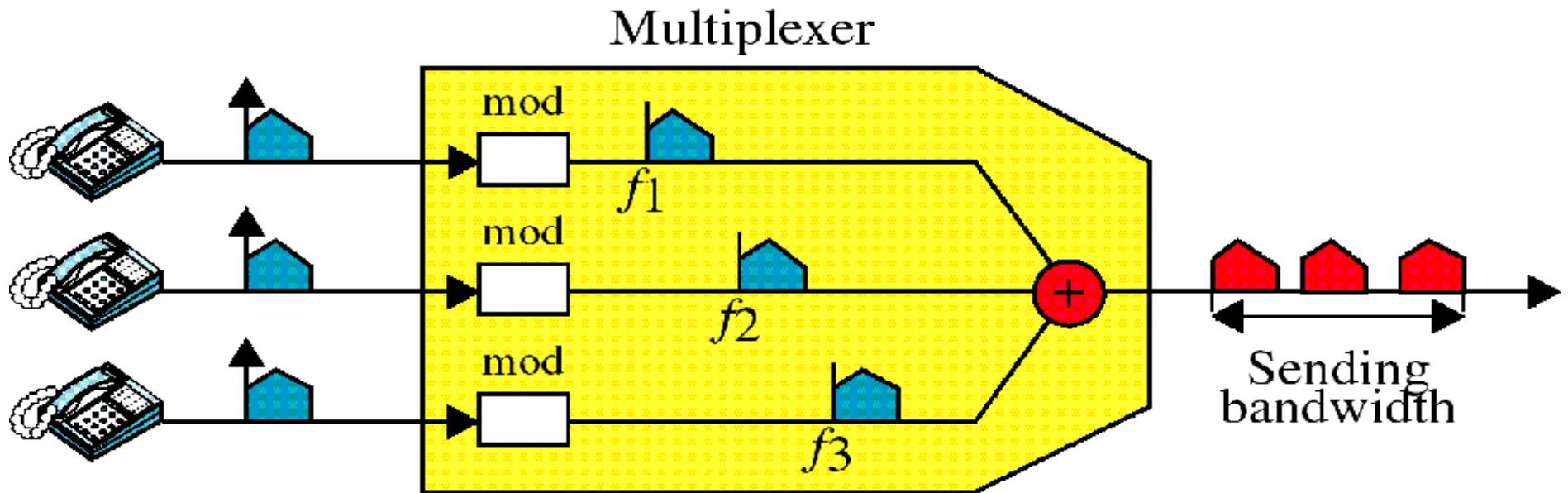

Demultiplexing, Time Domain

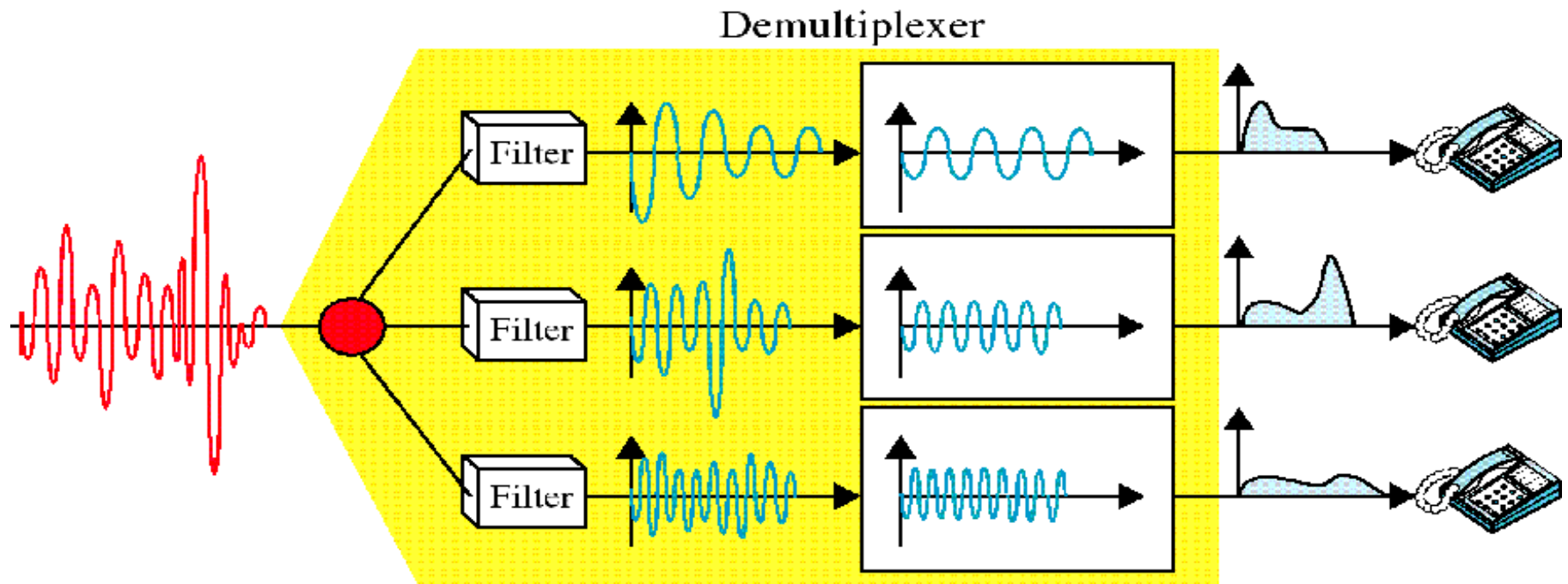

Demultiplexing, Freq. Domain

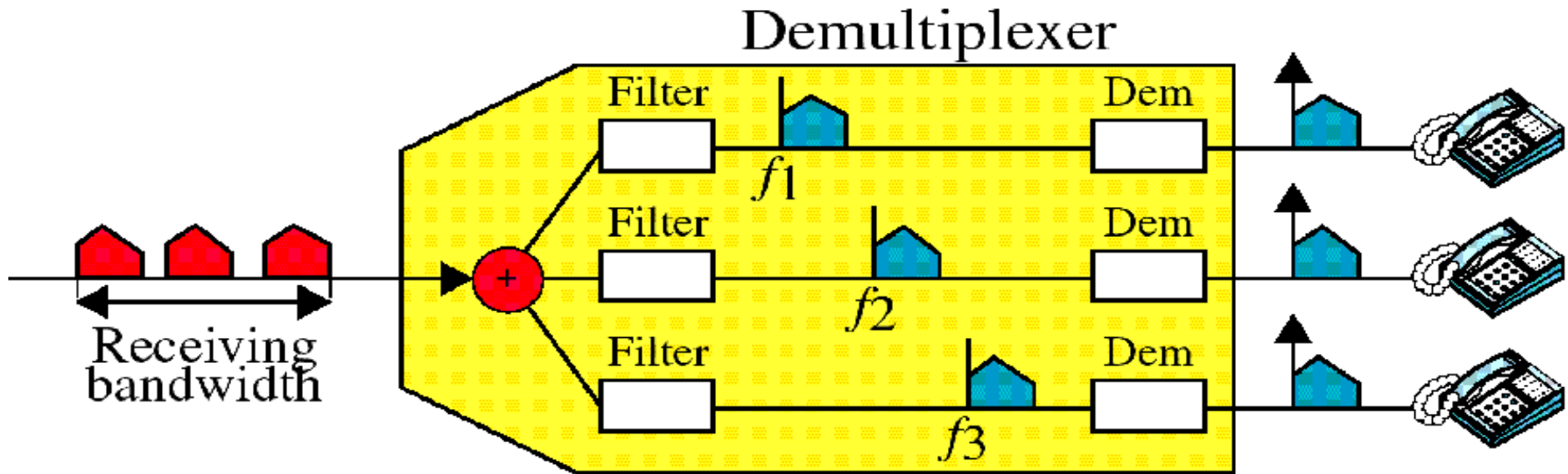



WDM

- Same as FDM but very higher frequency
- Light signal
- Optical fiber

WDM

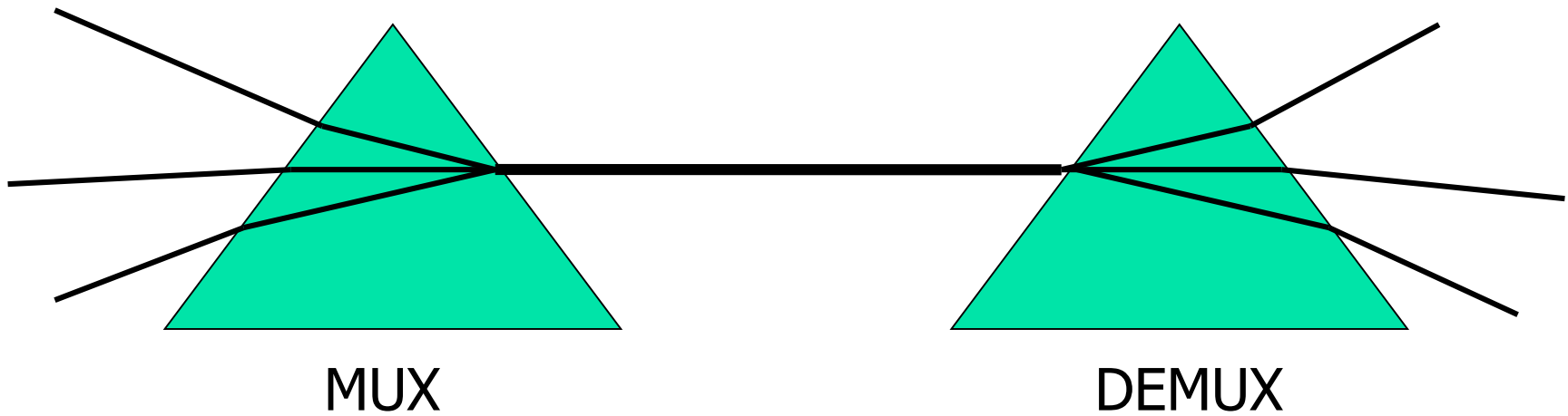
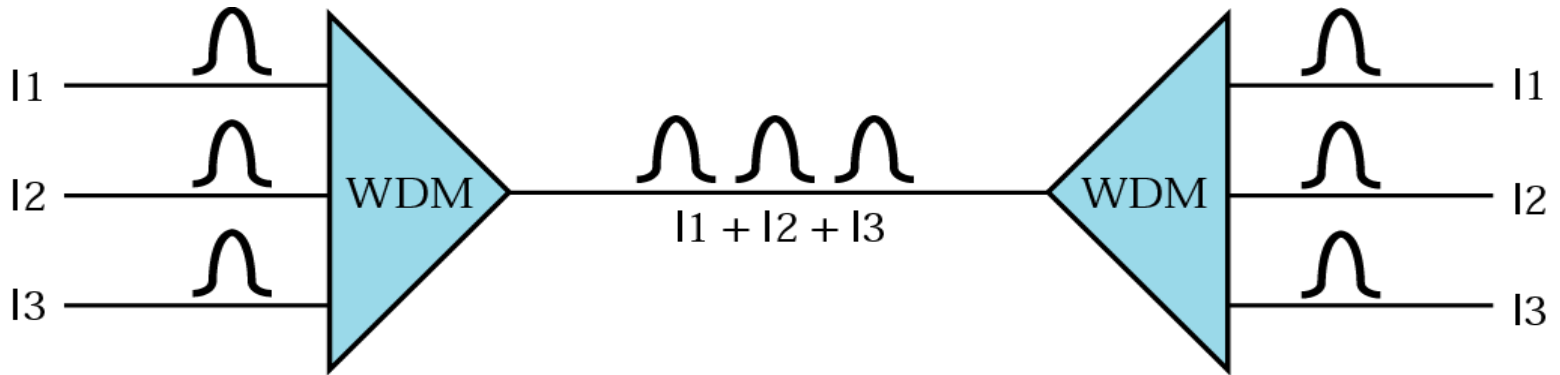

TDM

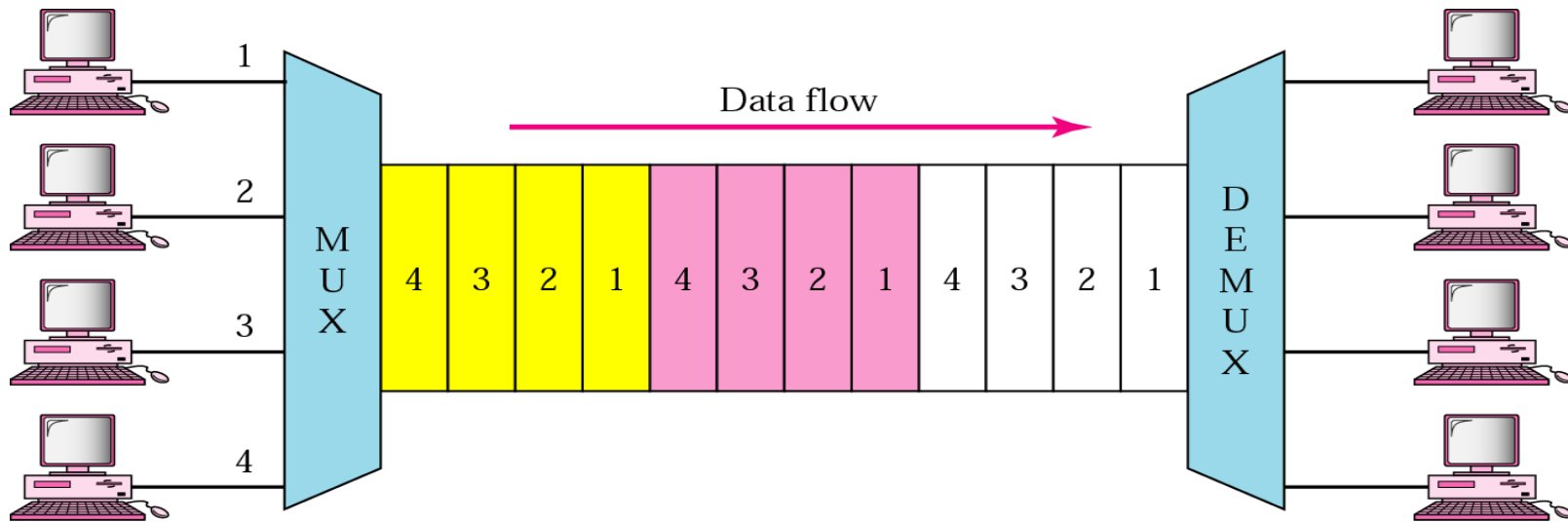

- Synchronous TDM
- Asynchronous TDM

Spread Spectrum Modulation

Amplitude

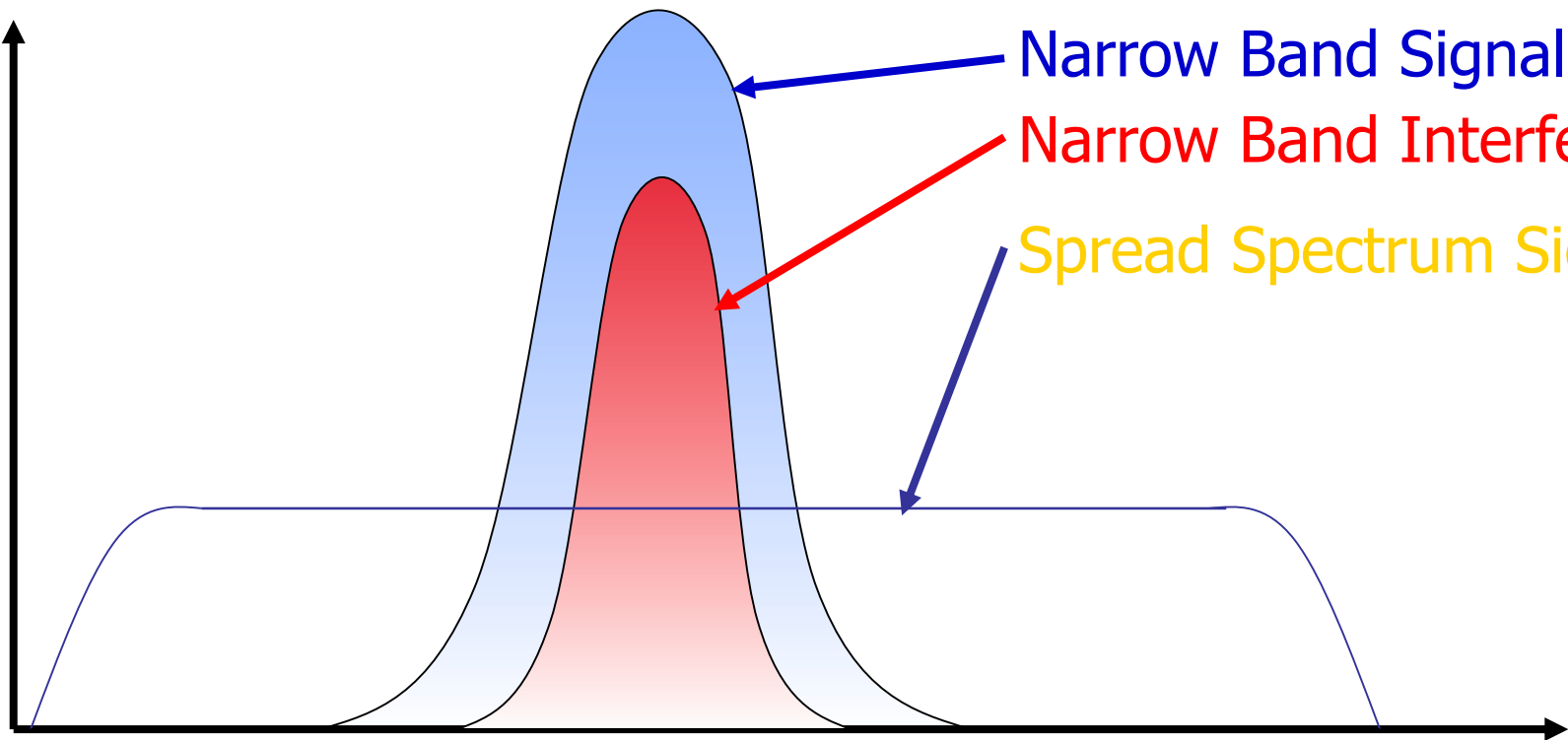

Narrow Band Signal

Narrow Band Interference

Spread Spectrum Signal

Frequency



Spread Spectrum Modulation

- Frequency Hopping Spread Spectrum (FHSS)
- Direct Sequence Spread Spectrum (DSSS)
- Orthogonal Frequency Division Multiplexing (OFDM)



Broadband VS. Baseband

- **Broadband**
 - Independent communication over a single medium
 - FDM
- **Baseband**
 - One communication over a single medium (at a time)
 - Ethernet



Summary

- Long-distance problem
- Carrier
- Modulation
- Modem
- Multiplexing
- Spread Spectrum