



# IEEE 802.11 Overview (1)

รศ. ดร. อนันต์ ผลเพิ่ม

Assoc. Prof. Anan Phonphoem, Ph.D.

[anan.p@ku.ac.th](mailto:anan.p@ku.ac.th)

Intelligent Wireless Network Group (IWING Lab)

<http://iwing.cpe.ku.ac.th>

Computer Engineering Department

Kasetsart University, Bangkok, Thailand



# Outline

---

- IEEE 802 Standards
- IEEE 802.11 Overview
- IEEE 802.11 Services
- History and present of IEEE 802.11



## Why Wireless LAN not so popular in the past?

---

- Low data rate
- High price
- Lack of standard
  - Proprietary products



# Types of Standards

---

- Official Standard
  - Controlled by an official standard organization
  - E.g. IEEE
- Public Standard
  - Controlled by a private organization
  - E.g. Wireless LAN Interoperability Forum
  - Called “De Facto Standard”



# Why Std. is so important?

- Interoperability
  - Multiple-vendor products
- Fast product development
  - Well-tested blueprint
- Stable for migration
  - IEEE 802.3 → 10 → 100/1000 Mbps
  - IEEE 802.11b → 802.11g → 802.11n
- Price Reduction
  - Low research & development budget
  - Increase price competition
- Easy to manage



# IEEE



- **I**nstitute for **E**lectrical and **E**lectronic **E**ngineers
- Nonprofit organization
- Publication, conferences, accreditation, standard developments
- Based in the US. → 150 countries



# IEEE 802 LAN Std. Family

802	Overview and Architecture
802.1	Network Management
<del>802.2</del>	<del>Logical Link Control (LLC)</del>
802.3	CSMA/CD - <b>Ethernet</b>
1802.3	Conformance Test Methodology for IEEE 802.3
<del>802.4</del>	<del>Token Passing Bus</del>
<del>802.5</del>	<del>Token Ring</del>
<del>802.6</del>	<del>Metropolitan Area Network (MAN) : DQDB</del>

<del>802.7</del>	<del>Broadband LAN</del>
<del>802.8</del>	<del>Fiber Optic</del>
<del>802.9</del>	<del>Isochronous LAN</del>
<del>802.10</del>	<del>Integrated Service Security</del>
802.11	<b>Wireless LAN</b>
<del>802.12</del>	<del>Demand Priority 100BaseVG</del>
802.15	<b>Wireless PAN</b>
802.16	Broadband Wireless Access ( <b>Wireless MAN</b> )
802.17	Resilient Packet Ring
802.21	<b>Media Independent Handoff</b>

~~————~~ Disbanded / Inactive



# IEEE 802 LAN Std. Family

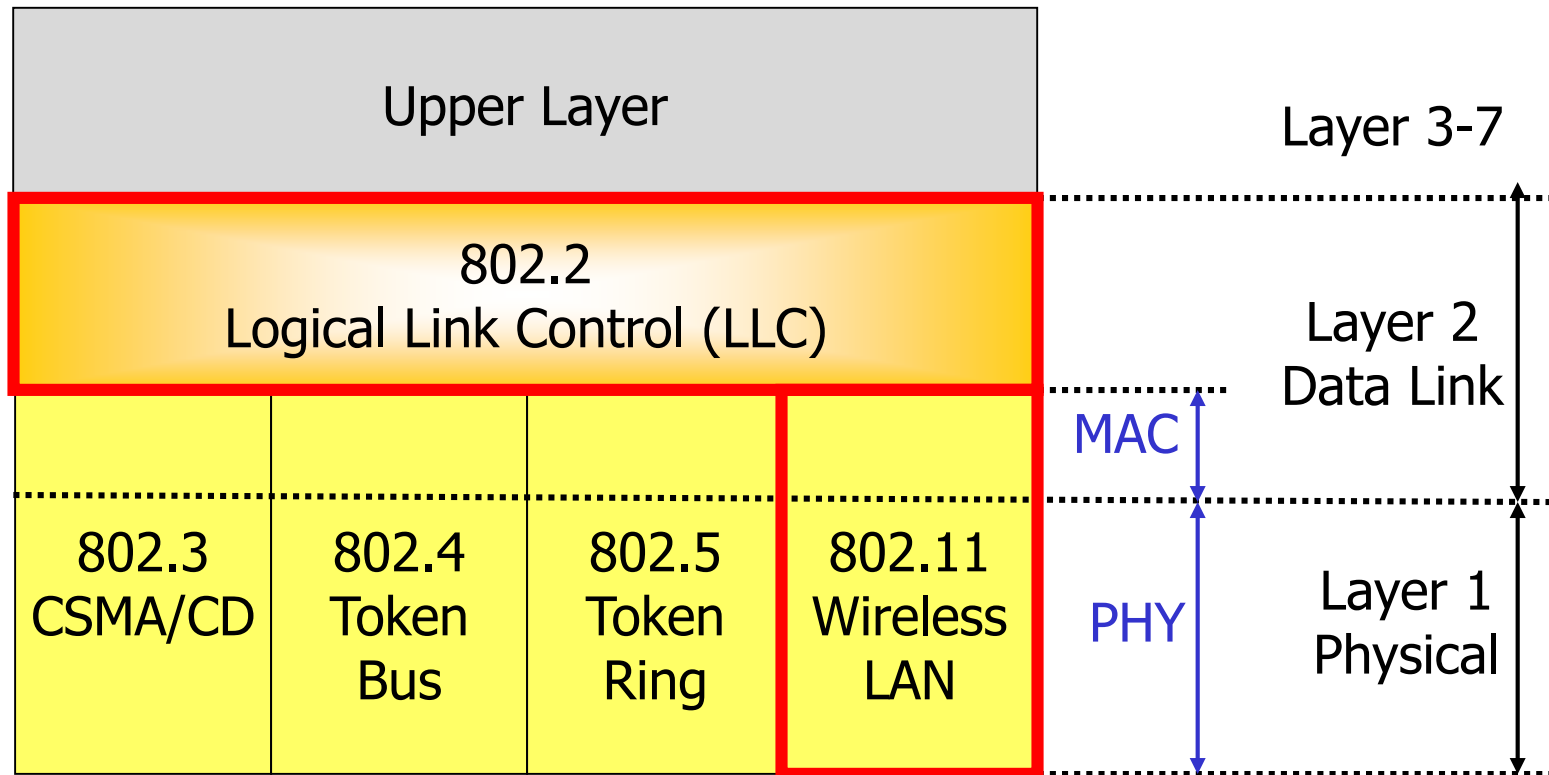





# IEEE 802.2 LLC

---

- Data link control protocol
- Exchange data between end users across LAN using a 802-based MAC
- Independent
  - Network topology
  - Transmission medium
  - MAC



# IEEE 802.2 LLC services

- Unacknowledged Connectionless
- Connection-oriented
- Acknowledged Connectionless

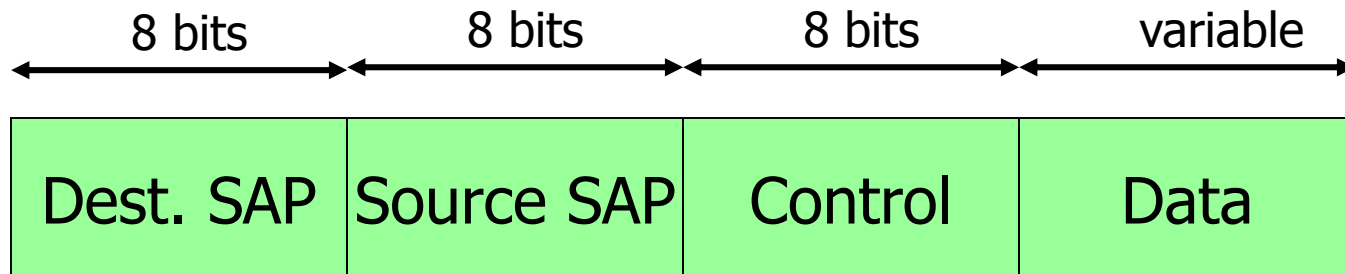

LLC Protocol Data Unit (PDU)



# Example I

Filter:  Expression... Clear Apply Save

No.	Time	Source	Destination	Protocol	Length	Info
233	2.865858		Apple_2c:7f:0c (RA)	802.11	10	Acknowledgement, Flags=...
234	2.878137		HonHaiPr_fd:98:51 (RA)	802.11	10	Acknowledgement, Flags=...
235	2.879672		HonHaiPr_fd:98:51 (RA)	802.11	10	Acknowledgement, Flags=...
236	2.881769	69.160.43.210	158.108.136.231	HTTP	1534	Continuation or non-HTTP tr...
237	2.881740		Cisco_6f:f6:c0 (RA)	802.11	10	Acknowledgement, Flags=...
238	2.882747		HonHaiPr_fd:98:51 (RA)	802.11	10	Acknowledgement, Flags=...
239	2.898644	Apple 4c:65:a3	Cisco 6f:f6:c0	802.11	24	Null function (No data). SM...

▸ Frame 236: 1534 bytes on wire (12272 bits), 1534 bytes captured (12272 bits)  
▸ IEEE 802.11 QoS Data, Flags: .....F.  
▸ Logical-Link Control  
▸ Internet Protocol Version 4, Src: 69.160.43.210 (69.160.43.210), Dst: 158.108.136.231 (158.108.136.231)  
▸ Transmission Control Protocol, Src Port: http (80), Dst Port: fjswapsnp (1874), Seq: 1, Ack: 1, Len: 1460  
▸ Hypertext Transfer Protocol

## Note:

1. turn off Network manager (top right of the screen)
2. Use airmoan-ng to change to promiscuous mode → create mon0
3. Use airodump-ng to capture and write to file
4. Open file with Wireshark

```
0000 88 02 2c 00 00 19 d2 82 6d eb 00 1e f7 6f f6 c0  ....m...O..
0010 00 00 0c 00 00 01 90 47 00 00 aa aa 03 00 00 00  ....G .....
0020 08 00 45 00 05 dc 27 56 40 00 2d 06 88 00 45 a0  ..E...'V@.-...E.
0030 2b d2 9e 6c 88 e7 00 50 07 52 0d c6 4f 95 b3 f0  +..l...P .R..0...
0040 86 8e 50 10 3d e0 ea 86 00 00 00 27 01 00 00 00  ..P=... ..'....
0050 00 00 02 69 41 9a 7c fd fa 52 22 3f 00 18 8f 4d  ...iA.|. .R"?...M
0060 7f dd 88 bd a1 c3 39 f8 e7 94 52 e2 ed 68 8b 2d  ....9. ..R..h.-
0070 df 66 4c 73 ad 42 70 d8 9d 01 c6 9b 9e 02 ef 44  fls Rn      D
```

Ready to load or capture      Packets: 375 Displayed: 375 Marked: 0 Load time: 0:00.003



# Example II

Filter:  Expression... Clear Apply Save

No.	Time	Source	Destination	Protocol	Length	Info
233	2.865858		Apple_2c:7f:0c (RA)	802.11	10	Acknowledgement, Flags=.....
234	2.878137		HonHaiPr_fd:98:51 (RA)	802.11	10	Acknowledgement, Flags=.....
235	2.879672		HonHaiPr_fd:98:51 (RA)	802.11	10	Acknowledgement, Flags=.....
236	2.881769	69.160.43.210	158.108.136.231	HTTP	1534	Continuation or non-HTTP traf
237	2.881740		Cisco_6f:f6:c0 (RA)	802.11	10	Acknowledgement, Flags=.....
238	2.882747		HonHaiPr_fd:98:51 (RA)	802.11	10	Acknowledgement, Flags=.....
239	2.898644	Apple 4c:65:a3	Cisco 6f:f6:c0	802.11	24	Null function (No data). SN=1

▸ Frame 236: 1534 bytes on wire (12272 bits), 1534 bytes captured (12272 bits)

▸ IEEE 802.11 QoS Data, Flags: .....F.

- Type/Subtype: QoS Data (0x28)
- Frame Control: 0x0288 (Normal)
- Duration: 44
- Destination address: Intel\_82:6d:eb (00:19:d2:82:6d:eb)
- BSS Id: Cisco\_6f:f6:c0 (00:1e:f7:6f:f6:c0)
- Source address: Cisco\_00:00:01 (00:00:0c:00:00:01)
- Fragment number: 0
- Sequence number: 1145
- QoS Control

▸ Logical-Link Control

▸ Internet Protocol Version 4, Src: 69.160.43.210 (69.160.43.210), Dst: 158.108.136.231 (158.108.136.231)

▸ Transmission Control Protocol, Src Port: http (80), Dst Port: fjswapsnp (1874), Seq: 1, Ack: 1, Len: 1460

▸ Hypertext Transfer Protocol

```
0000 88 02 2c 00 00 19 d2 82 6d eb 00 1e f7 6f f6 c0 ..... m...O..
0010 00 00 0c 00 00 01 90 47 00 00 aa aa 03 00 00 00 .....G .....
0020 08 00 45 00 05 dc 27 56 40 00 2d 06 88 00 45 a0 ..E...'V@.-...E.
0030 2b d2 9e 6c 88 e7 00 50 07 52 0d c6 4f 95 b3 f0 +..l...P .R..0...
0040 86 8e 50 10 3d e0 ea 86 00 00 00 27 01 00 00 00 ..P.=... '....
0050 00 00 02 69 41 9a 7c fd fa 52 22 3f 00 18 8f 4d ...iA.|. .R"?...M
0060 7f dd 88 bd a1 c3 39 f8 e7 94 52 e2 ed 68 8b 2d .....9. ..R..h.-
0070 df 66 4c 73 ad 42 70 d8 9d 01 c6 9b 9e 02 ef 44 fls Rn D
```

IEEE 802.11 wireless LAN (wlan), 2... Packets: 375 Displayed: 375 Marked: 0 Load time: 0:00.003



# Example III

Filter:  Expression... Clear Apply Save

No.	Time	Source	Destination	Protocol	Length	Info
233	2.865858		Apple_2c:7f:0c (RA)	802.11	10	Acknowledgement, Flags=...
234	2.878137		HonHaiPr_fd:98:51 (RA)	802.11	10	Acknowledgement, Flags=...
235	2.879672		HonHaiPr_fd:98:51 (RA)	802.11	10	Acknowledgement, Flags=...
236	2.881769	69.160.43.210	158.108.136.231	HTTP	1534	Continuation or non-HTTP tri
237	2.881740		Cisco_6f:f6:c0 (RA)	802.11	10	Acknowledgement, Flags=...
238	2.882747		HonHaiPr_fd:98:51 (RA)	802.11	10	Acknowledgement, Flags=...
239	2.898644	Apple 4c:65:a3	Cisco 6f:f6:c0	802.11	24	Null function (No data). SM

- Frame 236: 1534 bytes on wire (12272 bits), 1534 bytes captured (12272 bits)
- IEEE 802.11 QoS Data, Flags: .....F.
- **Logical-Link Control**
  - DSAP: SNAP (0xaa)
  - IG Bit: Individual
  - SSAP: SNAP (0xaa)
  - CR Bit: Command
  - Control field: U, func=UI (0x03)
    - Organization Code: Encapsulated Ethernet (0x000000)
    - Type: IP (0x0800)
- Internet Protocol Version 4, Src: 69.160.43.210 (69.160.43.210), Dst: 158.108.136.231 (158.108.136.231)
- Transmission Control Protocol, Src Port: http (80), Dst Port: fjswapsnp (1874), Seq: 1, Ack: 1, Len: 1460
- Hypertext Transfer Protocol

```
0000 88 02 2c 00 00 19 d2 82 6d eb 00 1e f7 6f f6 c0  ....m...O..
0010 00 00 0c 00 00 01 90 47 00 00 aa aa 03 00 00 00  ....G ..
0020 08 00 45 00 05 dc 27 56 40 00 2d 06 88 00 45 a0  .E...'V@.-...E.
0030 2b d2 9e 6c 88 e7 00 50 07 52 0d c6 4f 95 b3 f0  +.l...P .R..0...
0040 86 8e 50 10 3d e0 ea 86 00 00 00 27 01 00 00 00  .P.=... '....
0050 00 00 02 69 41 9a 7c fd fa 52 22 3f 00 18 8f 4d  ...iA.|. .R"?...M
0060 7f dd 88 bd a1 c3 39 f8 e7 94 52 e2 ed 68 8b 2d  ....9. ..R..h.-
0070 df 66 4c 73 ad 42 70 d8 9d 01 c6 9b 9e 02 ef 44  fls Rn      D
```

Logical-Link Control (llc), 8 bytes    Packets: 375 Displayed: 375 Marked: 0 Load time: 0:00.003



# Outline

---

- IEEE 802 Standards
- IEEE 802.11 Overview
- IEEE 802.11 Services
- History and present of IEEE 802.11



# IEEE 802.11 design concern

---

- Wireless / Wired LANs Differences
- Power management
  - Switch to low power mode (sleep)
- Bandwidth
  - Compress data, utilize of the available BW
- Security
  - Works with IEEE 802.10
- Addressing
  - Location / destination address → mobileIP



# IEEE 802.11 Logical Architecture

- Deliver **MAC Service Data Unit** (MSDU) between peer LLC
- Transparent to higher layer (LLC)
- Provide both MAC and PHY functionality
- Typically resides in NIC or Access Point

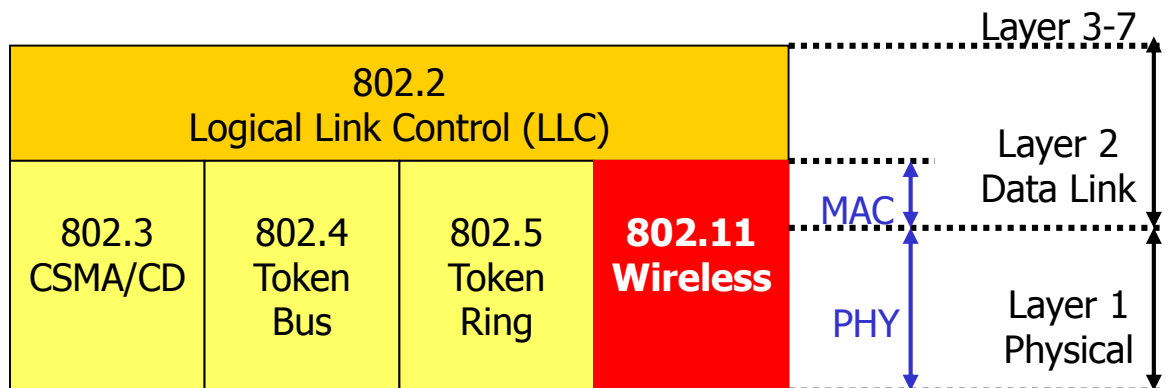





# IEEE 802.11 Logical Architecture

- Define the network operation
  - Topology → necessary physical components

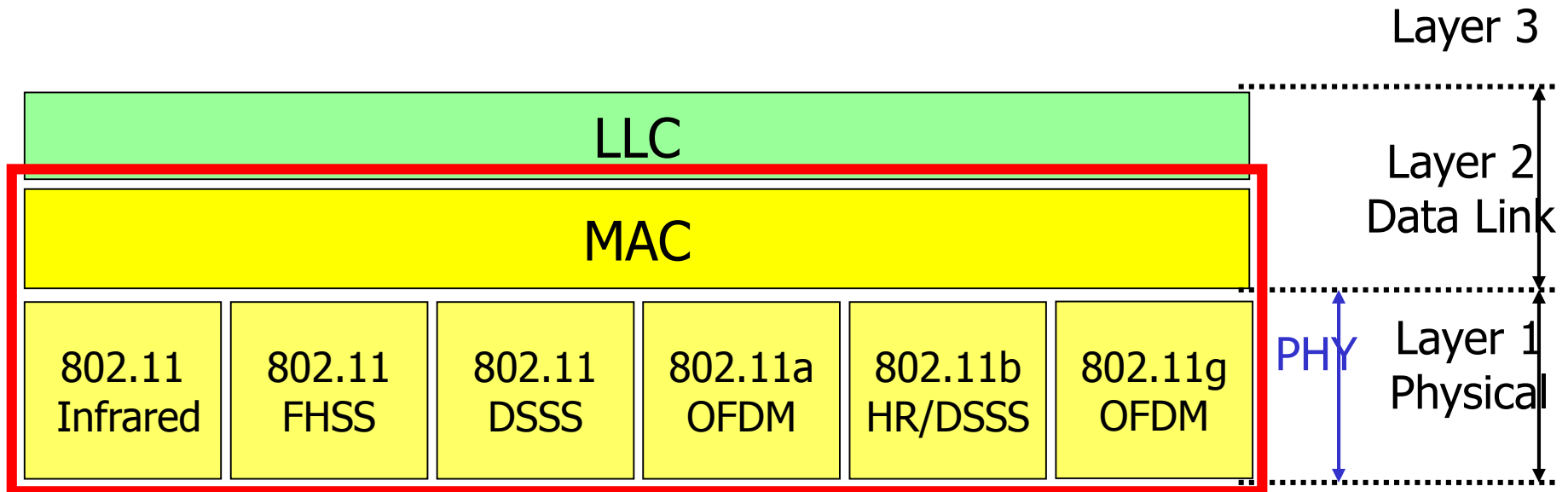



# 802.11 MAC Layer

---

- Provide access control functions
  - Addressing
  - Access coordination
  - Frame check generating / checking
  - LLC PDU delimiting
- CSMA/CA
  - Cannot Tx/Rx simultaneously



# 802.11 Physical Layers

---

## Radio Frequency

- Frequency Hopping Spread Spectrum (FHSS)
- Direct Sequence Spread Spectrum (DSSS)
- Orthogonal Frequency Division Multiplexing (OFDM)



# 802.11 Physical Layers

---

## Infrared

- 850-950 nM, Peak power = 2 Watts
- 16-Pulse position Mod, PPM (1 Mbps)
- 4-PPM (2 Mbps)



# IEEE 802.11 Topology

---

- Independent Basic Service Set (IBSS)
- Extended Service Set (ESS)

# Independent Basic Service Set (IBSS)



- Stand-alone BSS
- No backbone infrastructure
- At least 2 stations
- **Ad hoc** Network
- Small area

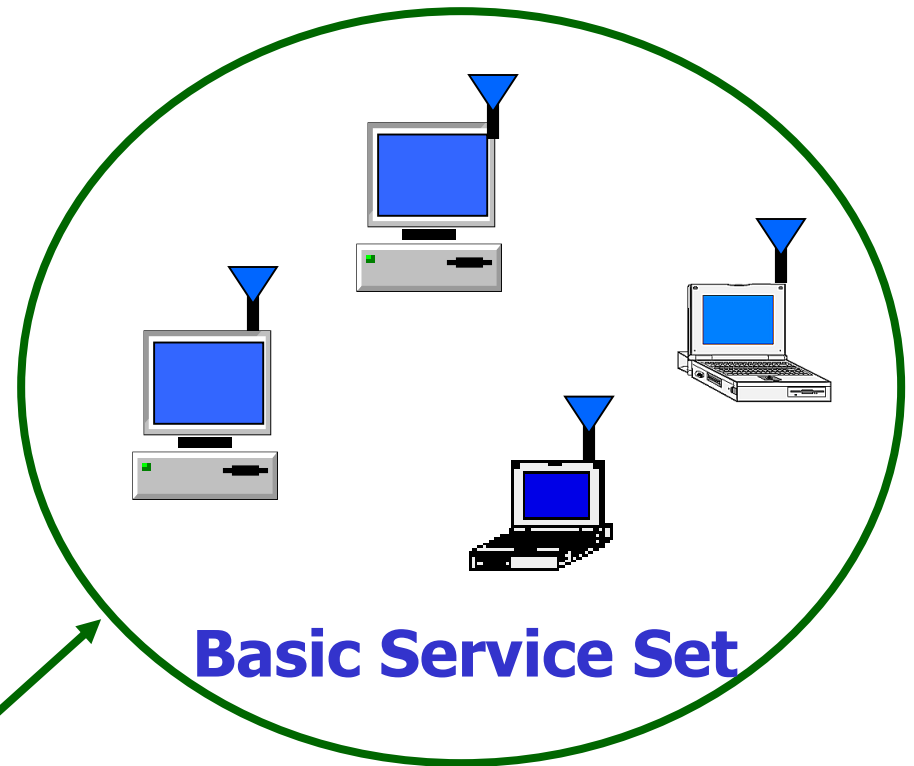

Cell Boundary



# Infrastructure Basic Service Set

- Stand-alone BSS
- Connect to backbone infrastructure
- Access Point
- Small area

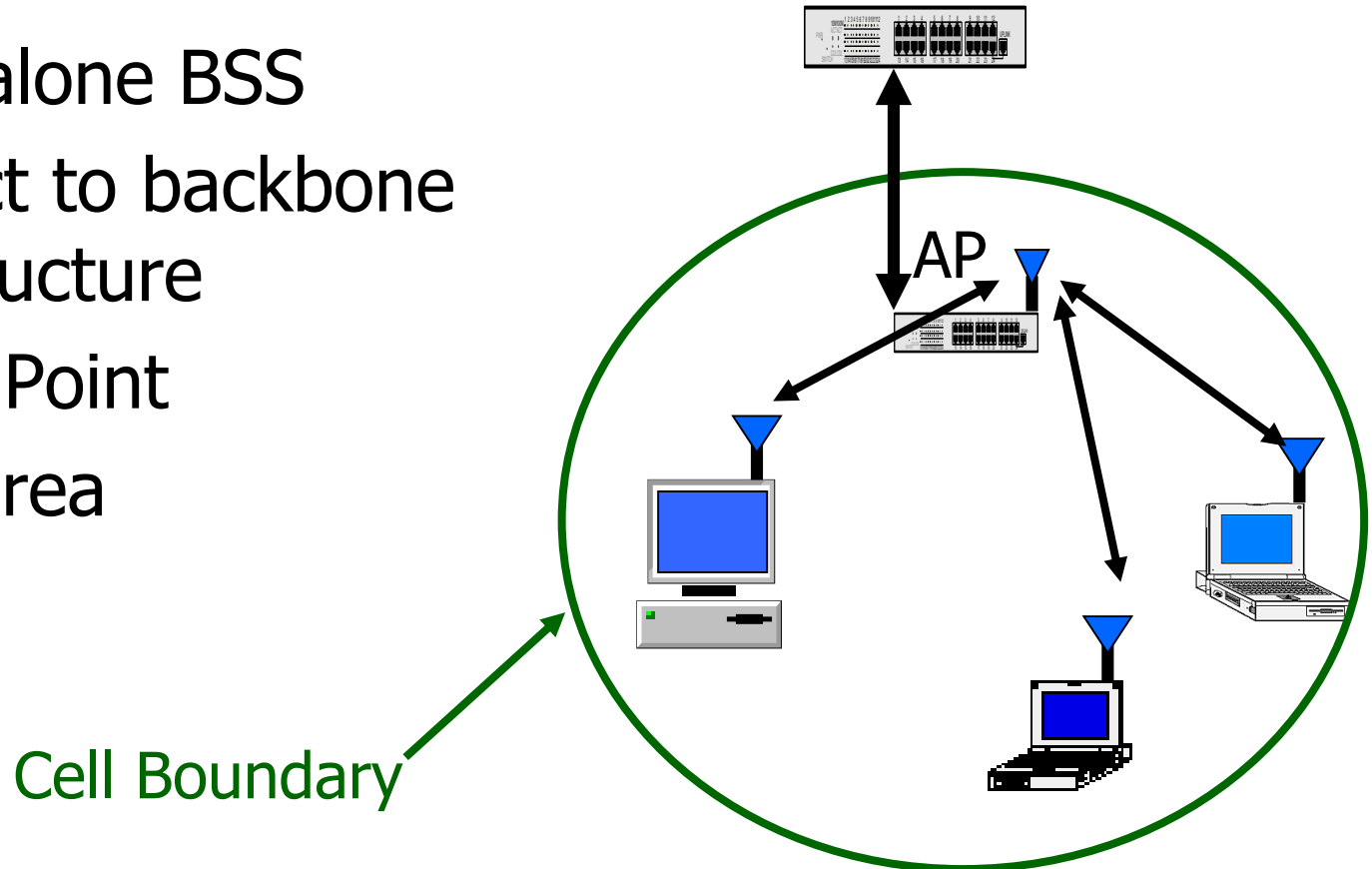



# Extended Service Set (ESS)

- Extending range
- Arbitrary size
- Multiple cells interconnect
- Need Access Point and Distributed system

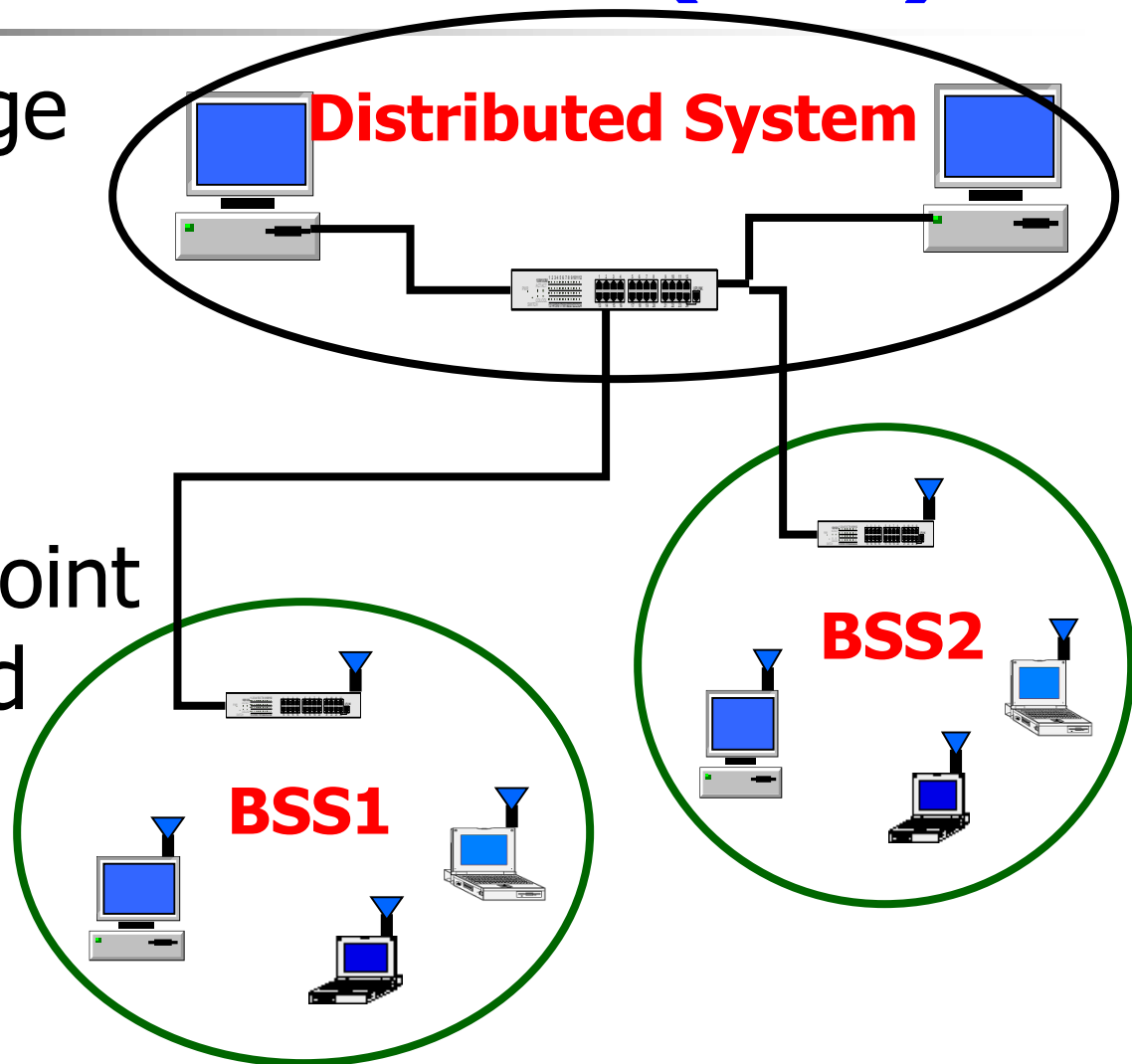





# 802.11 Mobility Types

- No-transition
  - Not move
  - Moving within a local BSS
- BSS-transition
  - Move from one BSS to another BSS, same ESS
- ESS-transition
  - Move from one BSS to another BSS, different ESS
- Guarantee for No-transition and BSS-transition
- IBSS & ESS are transparent to the LLC



# ESS Physical Configuration

- Partial overlap
  - Contiguous coverage in a defined area
  - No disruption

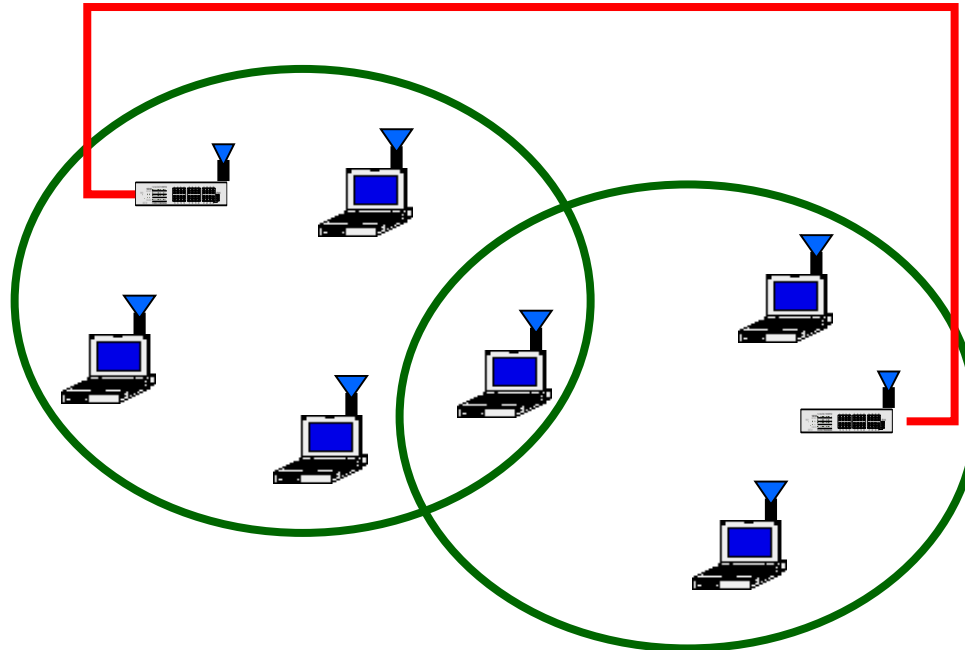



# ESS Physical Configuration

- Physical disjoint
  - No contiguous coverage → no distance limit

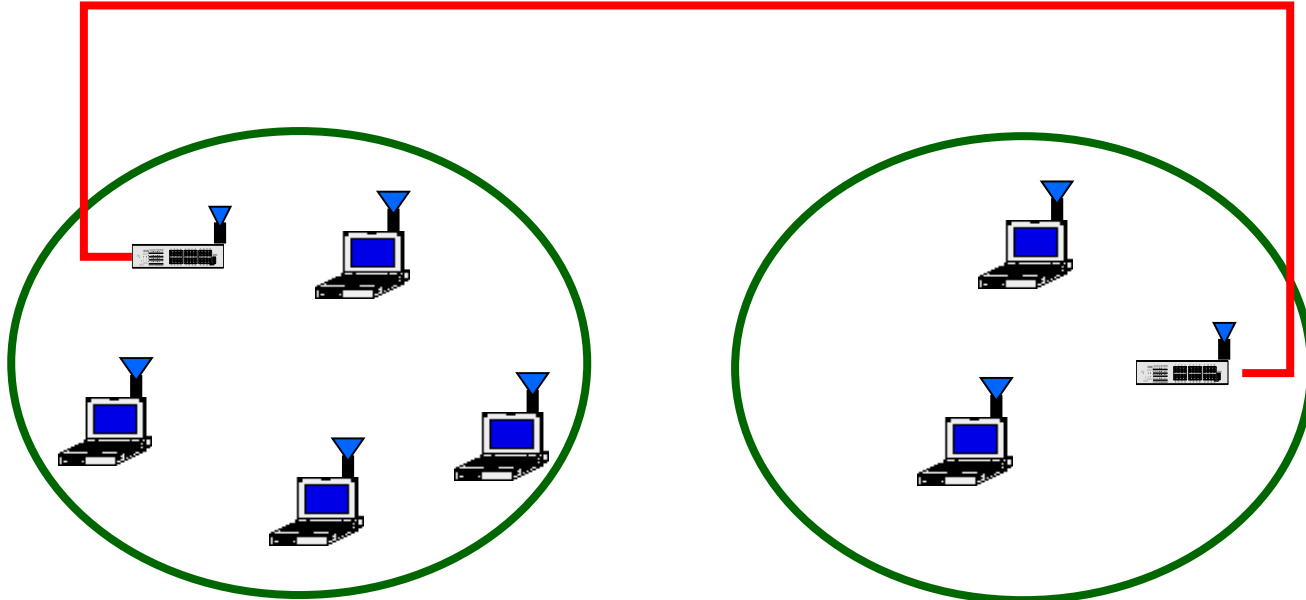



# ESS Physical Configuration

- Physical collocate
  - Redundant or high-performance network

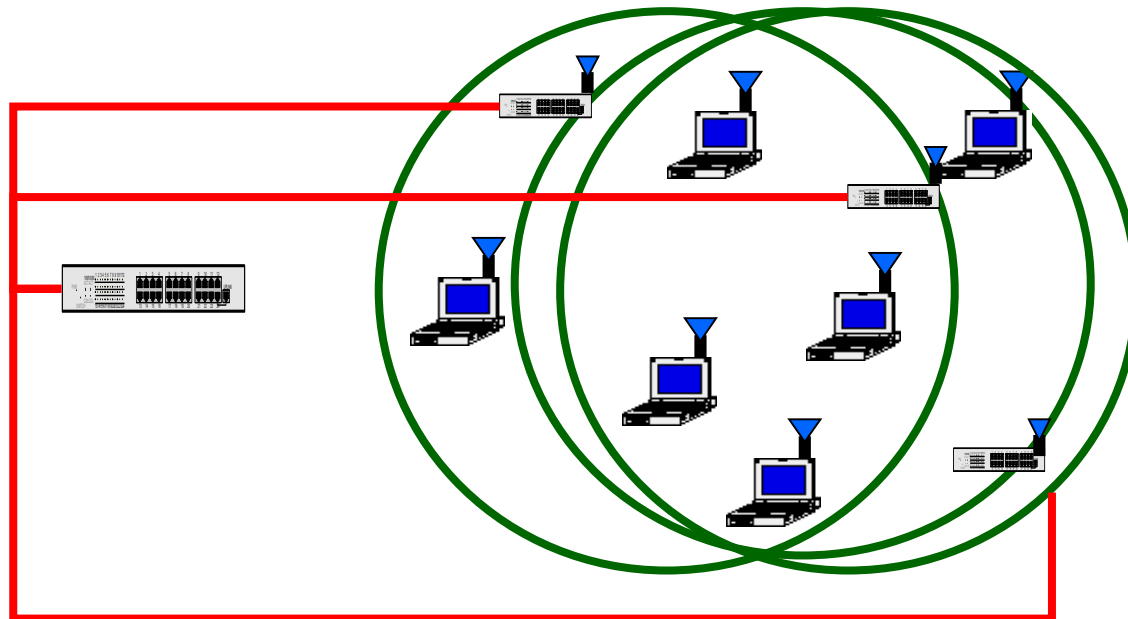



# Outline

---

- IEEE 802 Standards
- IEEE 802.11 Overview
- **IEEE 802.11 Services**
- History and present of IEEE 802.11



# 802.11 Services

---

- Station Services (in wireless station)
  - Authentication / Deauthentication
  - Privacy
  - MSDU delivery
- Distribution System Services
  - Association / Disassociation / Reassociation
  - Distribution / Integration



# Authentication

---

- Prevent unauthorized access
- Open system authentication
  - send authen. with ID → get back if recognize
- Shared key authentication
  - Secret shared key (through secure channel)
  - Authen. through shared key
  - Required Wireless Equivalent Privacy Algorithm (WEP) /or others



# Privacy

- 802.11 offers a privacy service option
- Based on 802.11 Wired Equivalent Privacy (WEP) algorithm

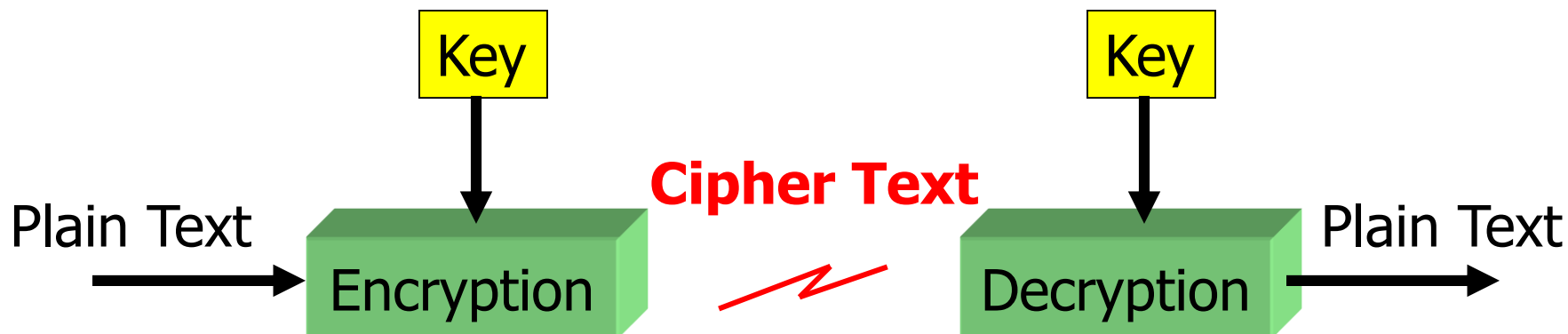





# Association

---

- Perform @ access point
- Map a station to the distribution system via access point
- Otherwise the transmission is not allowed



# Reassociation

---

- Change the status of association
- Support BSS-transition mobility
- Change the association attribute



# 802.11 State Diagram

