



# IEEE 802.11 MAC

รศ. ดร. อนันต์ ผลเพิ่ม

Assoc. Prof. Anan Phonphoem, Ph.D.

[anan.p@ku.ac.th](mailto:anan.p@ku.ac.th)

Intelligent Wireless Network Group (IWING Lab)

<http://iwing.cpe.ku.ac.th>

Computer Engineering Department

Kasetsart University, Bangkok, Thailand



# MAC Layer

- **MAC Layer operation**
  - Contention & contention-free
  - Priority frame transmission
- MAC frame structure
  - Create MAC frame
- MAC frame Types
  - MAC management, control, and data frame



# MAC Layer Operations

---

- Accessing the wireless medium
- Joining the network
- Providing authentication and privacy



# Accessing Wireless Medium

---

- Two operation modes
  - Distributed Coordination Function (DCF)
  - Point Coordination Function (PCF)
- The coexist of DCF & PCF
- PCF & DCF tradeoff

# Distributed Coordination Function (DCF)



- CSMA/CA
- Error Recovery Mechanism
- Carrier Sense Mechanism
- Access Spacing



# CSMA/CD

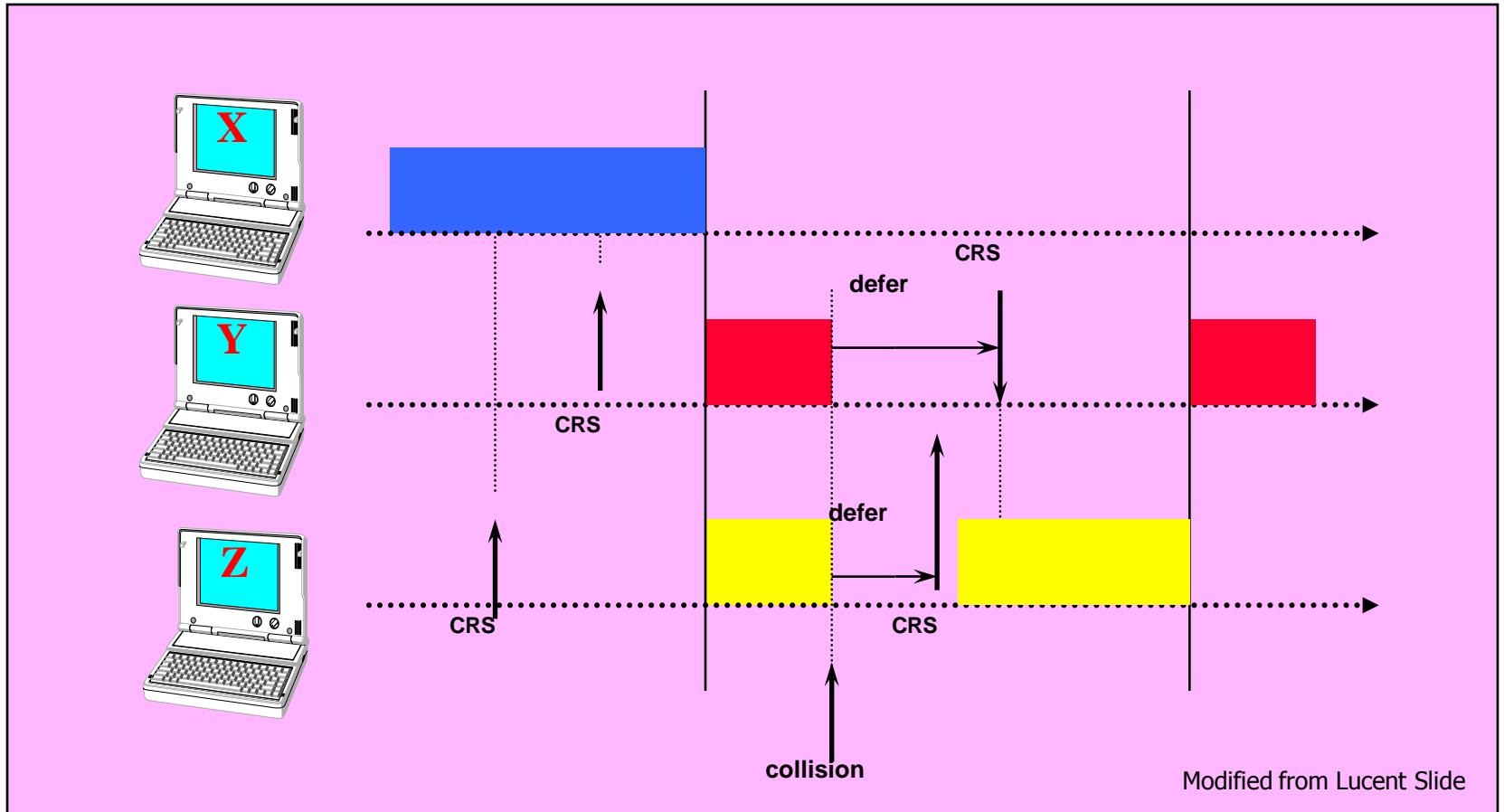



# DCF - CSMA/CA

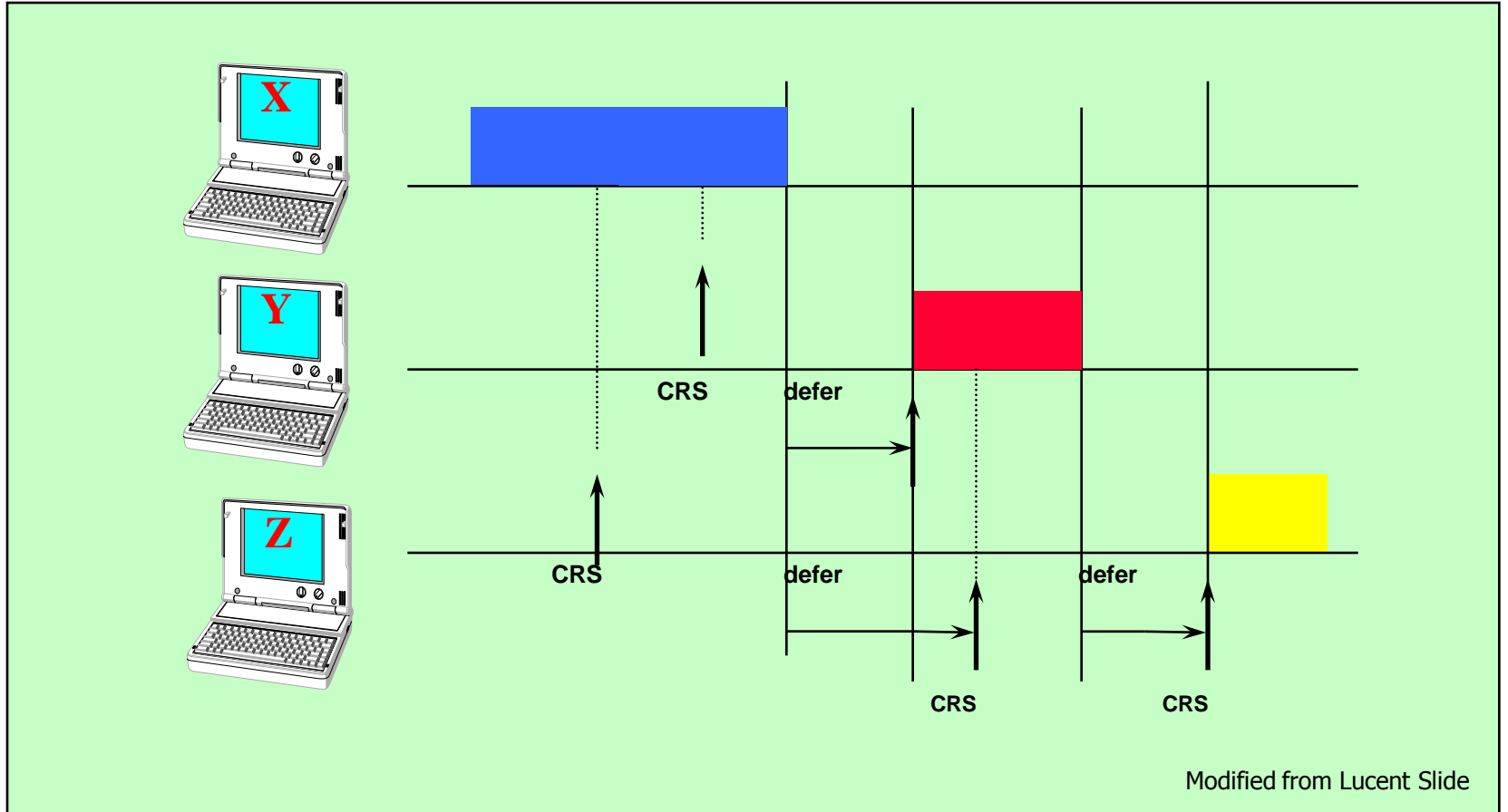



# Error Recovery Mechanism

---

- Transmission impairments
  - Errors (interference, collision)
- Handshake mechanism
  - RTS: Request to send
  - CTS: Clear to send
  - ACK: Acknowledge
  - Data: Data Frame





# Handshake Mechanism

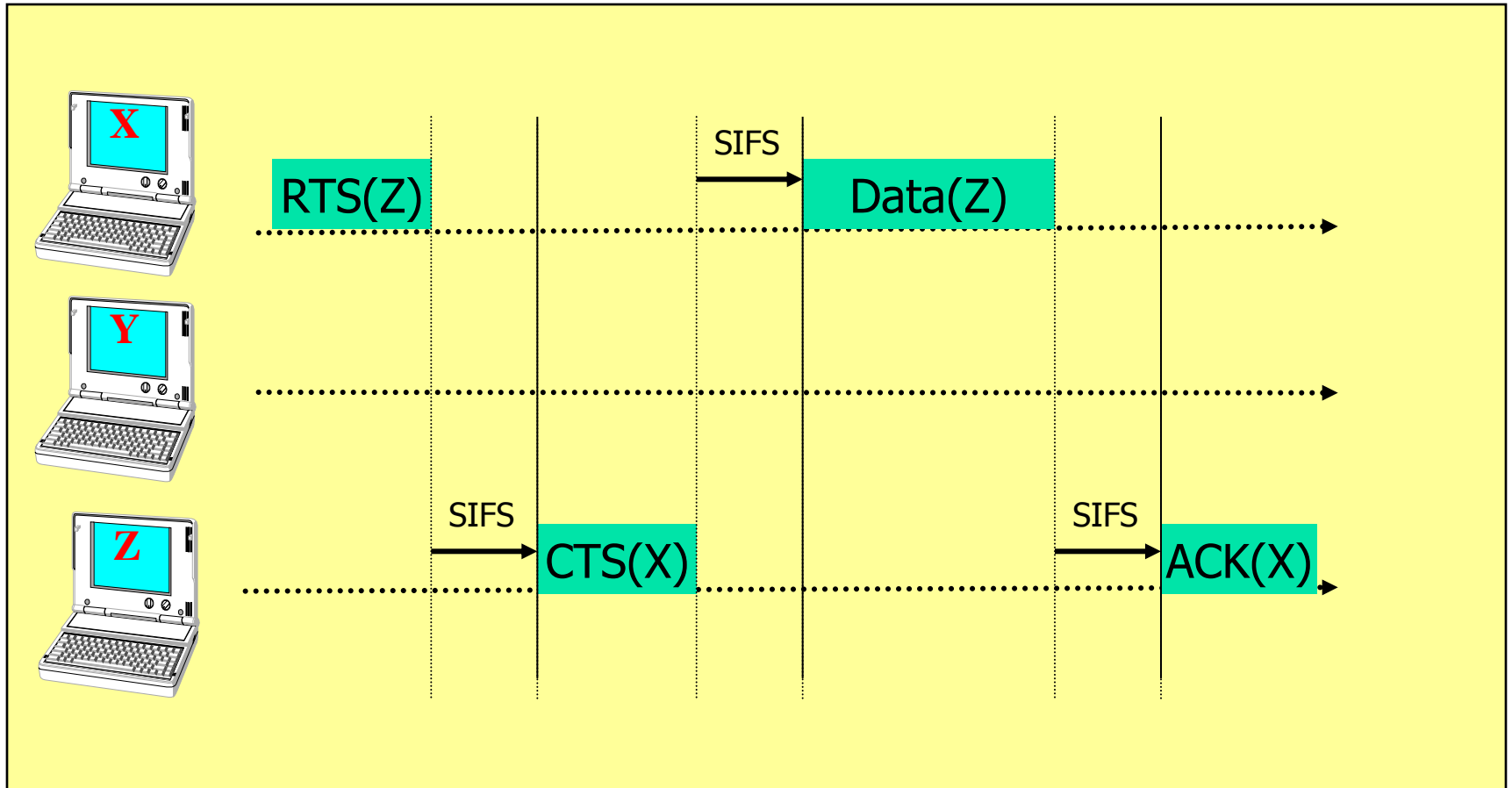



# Carrier Sense Mechanism

---

- Check for Availability of the Medium
  - Status = Idle / Busy
- Two methods
  - Physical Carrier Sense  
(Physical Channel Assessment)
  - Virtual Carrier Sense  
(Network Allocation Vector: NAV)



# Physical Carrier Sense

- Depend on the modulation techniques/medium
- Cannot Tx and Rx simultaneously  
(1 Transciever: too expensive → not now: MIMO)
- Hidden nodes

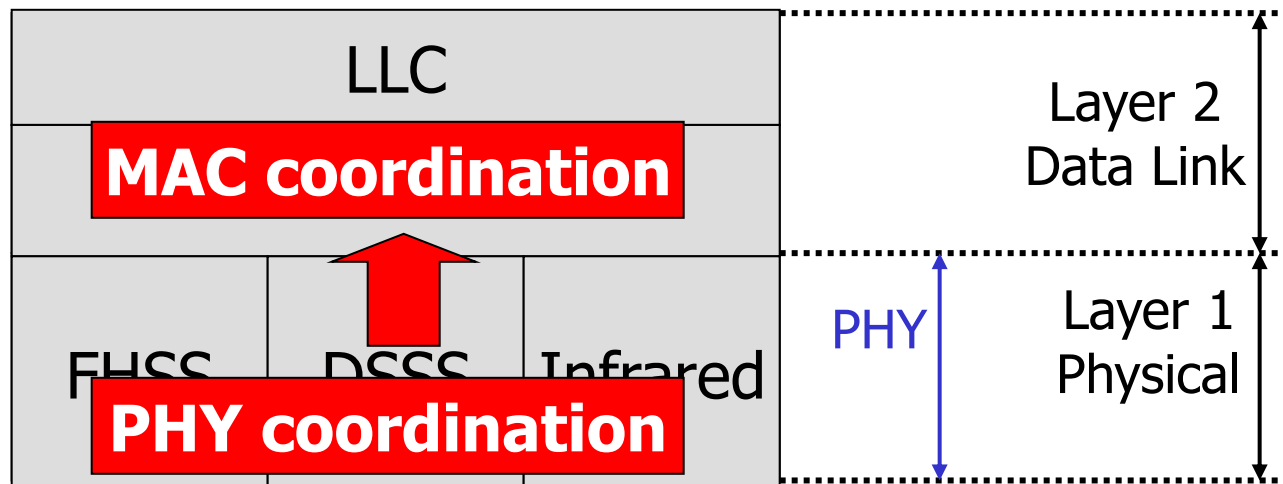



# Virtual Carrier Sense

- Used “Network Allocation Vector” (NAV)
  - A timer for channel reserved period
  - Included in the RTS and CTS frames
  - Each station will count down until  $NAV = 0$
  - If  $NAV \neq 0 \rightarrow$  Medium is Busy
  - If  $NAV = 0 \rightarrow$  Medium is idle



# Virtual Carrier Sense

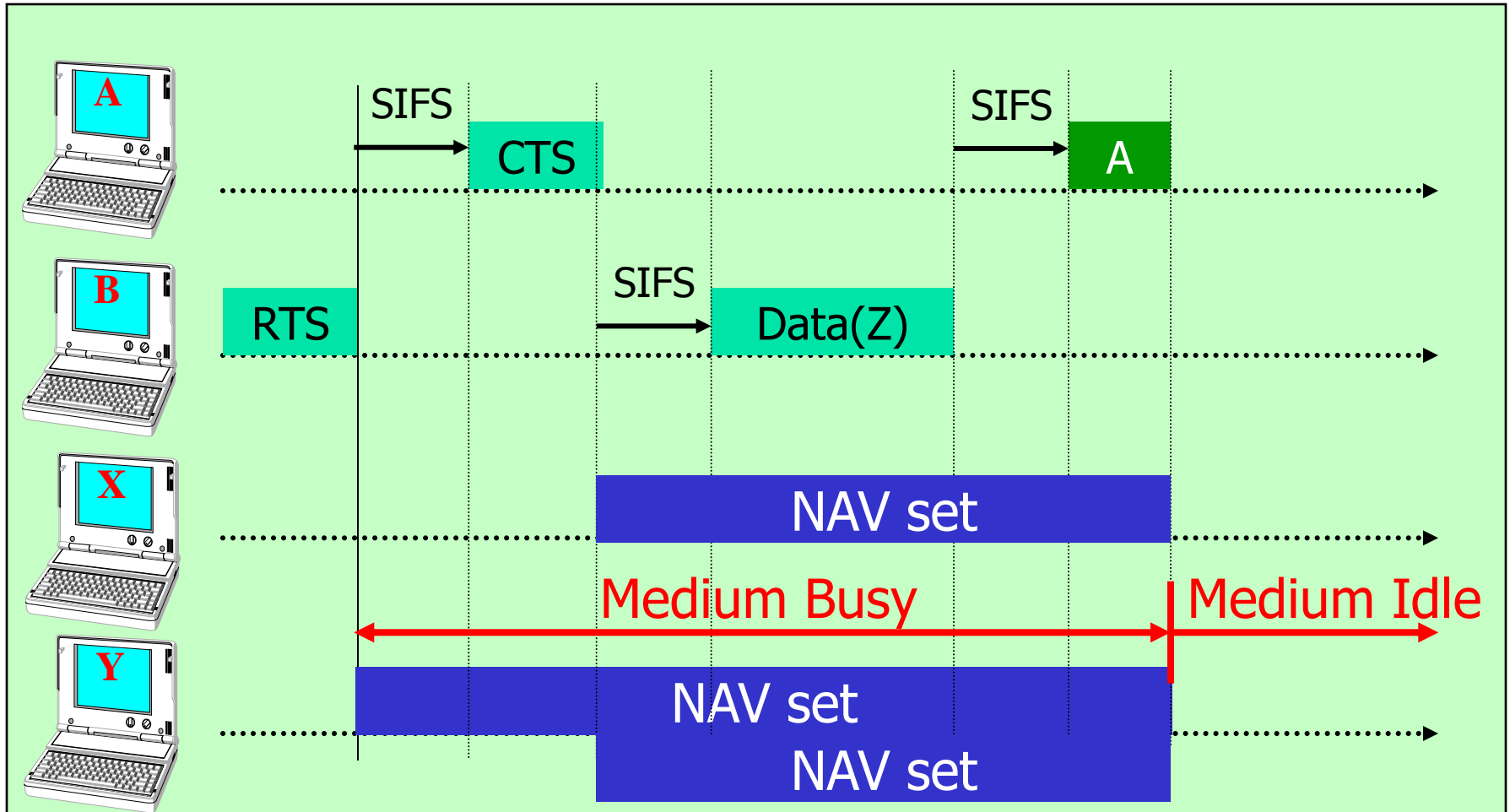



# Access Spacing

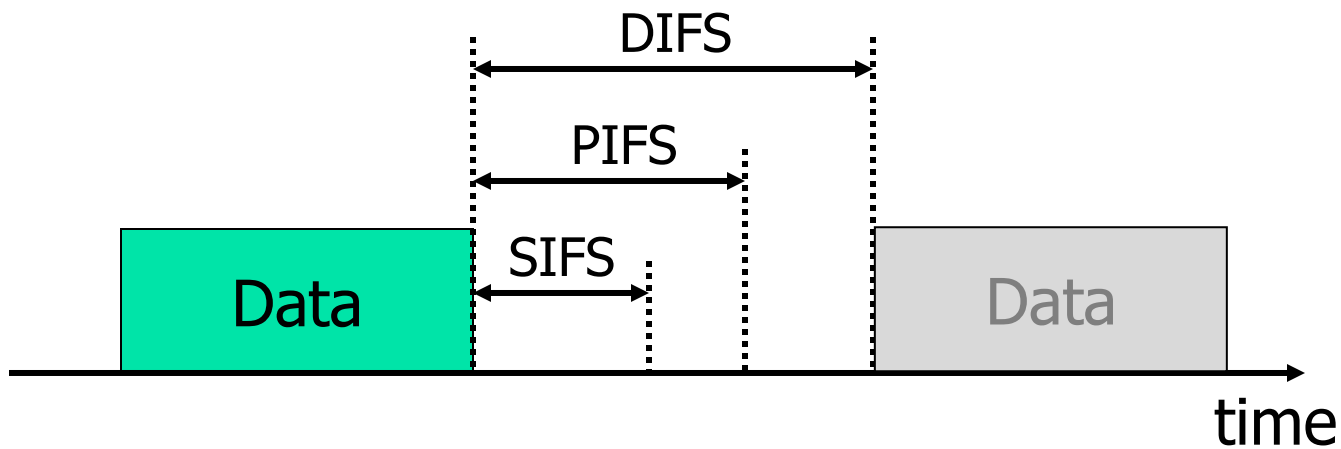

IFS	Interframe Space	Priority	Usage
SIFS	Short IFS	Highest priority	ACK, CTS, 2 <sup>nd</sup> MSDU
PIFS	PCF IFS	2 <sup>nd</sup> priority	PCF operation mode
DIFS	DCF IFS	3 <sup>rd</sup> priority	DCF operation mode
EIFS	Extended IFS	Lowest priority	Waiting period



# Sending Data and Ack

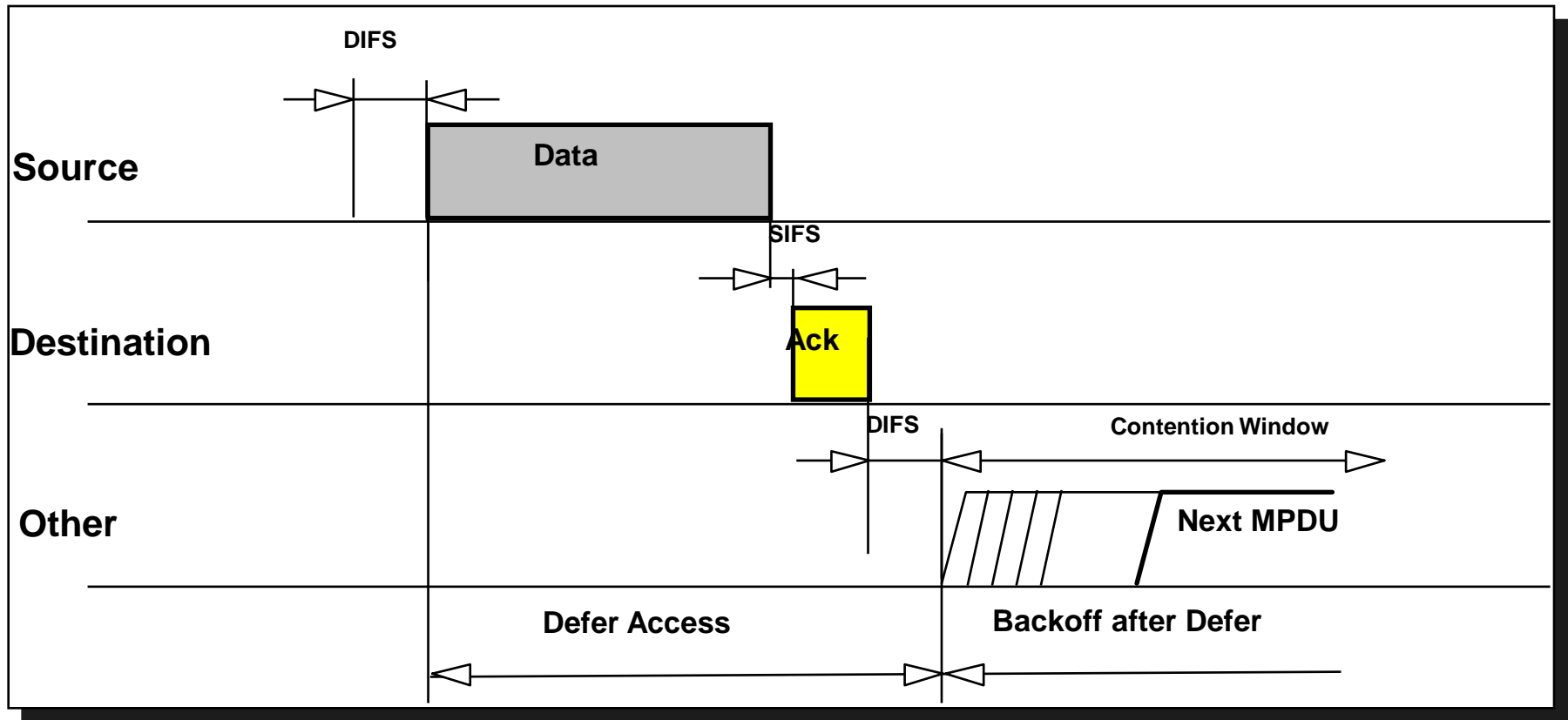



# DCF Backoff

- Similar to Ethernet
- Each retry  
→ window size increases
- For DSSS
  - Contention window =  $2^n - 1$
  - Smallest = 31, Biggest = 1023

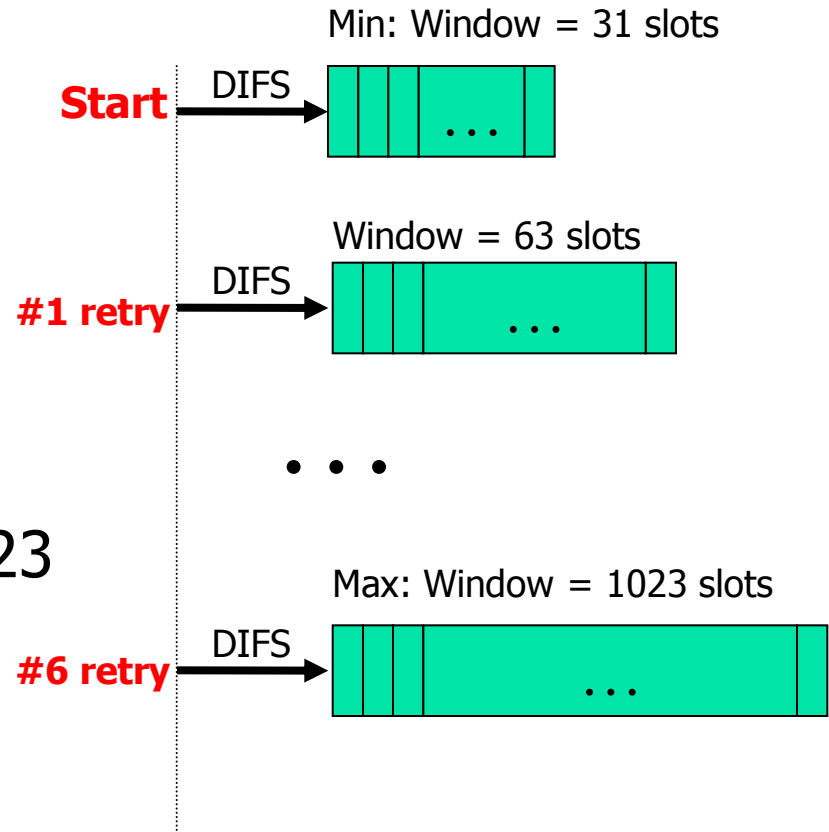





# Some DCF rules

---

- If medium idle after DIFS
  - Tx can begin
  - If no error → medium must be free for DIFS
  - If error → medium must be free for EIFS
- If medium Busy
  - Defer Access
- Positive ACK is required (For unicast)



# Accessing Wireless Medium

---

- Two operation modes:
  - Distributed Coordination Function (DCF)
  - Point Coordination Function (PCF)
- They coexist of DCF & PCF
- PCF & DCF tradeoff



# Point Coordination Function (PCF)

---

- Priority-based  $\rightarrow$  QoS
- Contention-free frame transfer
- Optional



# PCF operation

- Point Coordinator (PC) takes control the medium
  - Sense the medium @ beginning of PCF period
  - If idle after PIFS interval, sends Beacon frame
  - Beacon includes CF parameters (CFPMaxDuration : length of CF period)
- All stations receive Beacon:
  - Update NAV with the CFPMaxDuration
  - Cannot take control the medium until CF period ends



# PCF operation

- After SIFS interval, PC may transmit
  - Data frame (PC → station)
    - Individual, broadcast, multicast
    - Immediate retransmit is allowed (PIFS)
  - CF Poll frame
    - Grants permission to stations
    - Can transmit to any destination
    - Only single frame allowed per poll
  - Data + CF Poll frame (piggyback)
  - CF End frame
    - Announce the end of CF period



# PCF operation

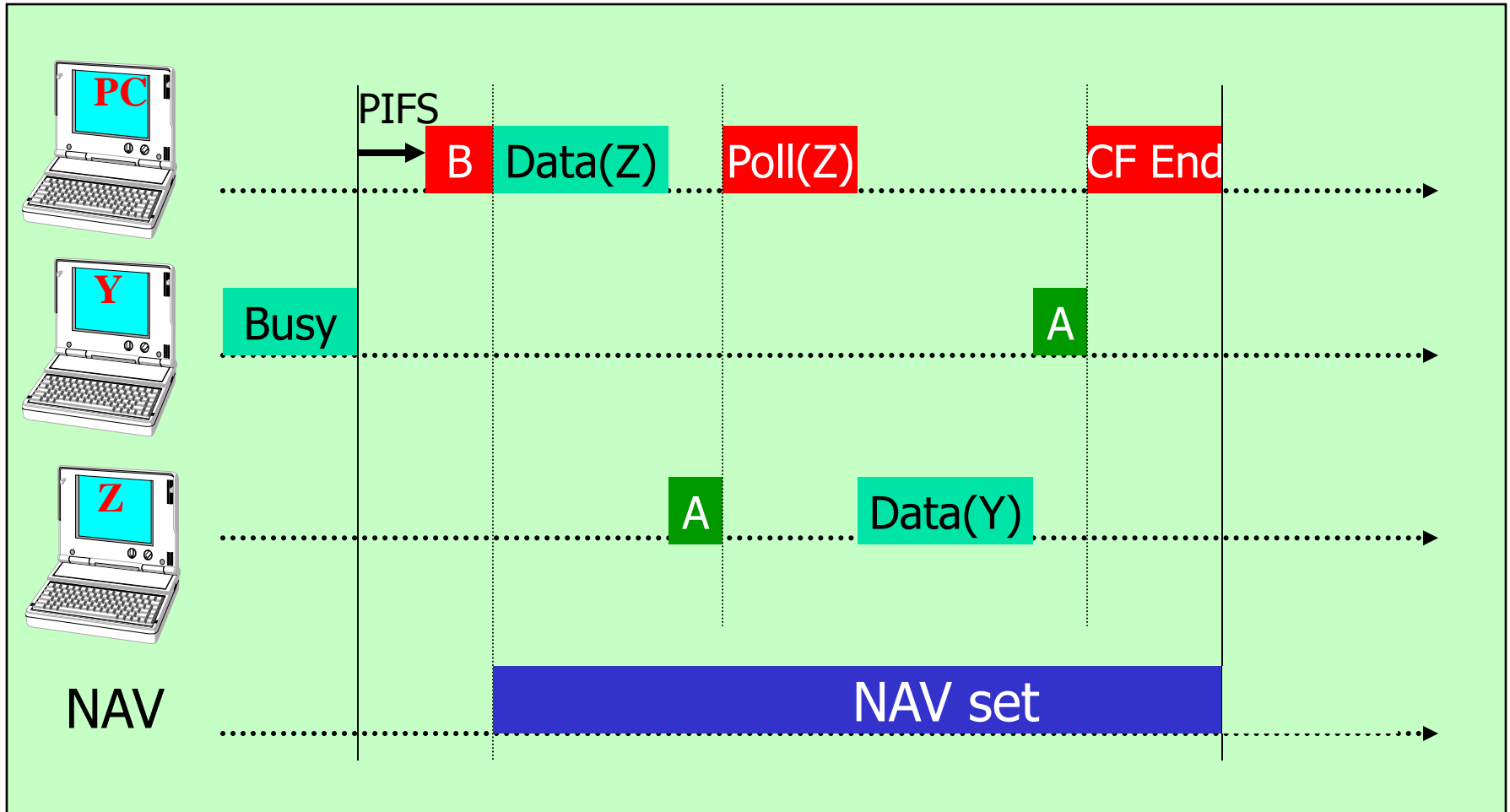

# Accessing the Wireless Medium



- Two operation modes:
  - Distributed Coordination Function (DCF)
  - Point Coordination Function (PCF)
- The coexist of DCF & PCF
- PCF & DCF tradeoff



# The coexist of DCF & PCF

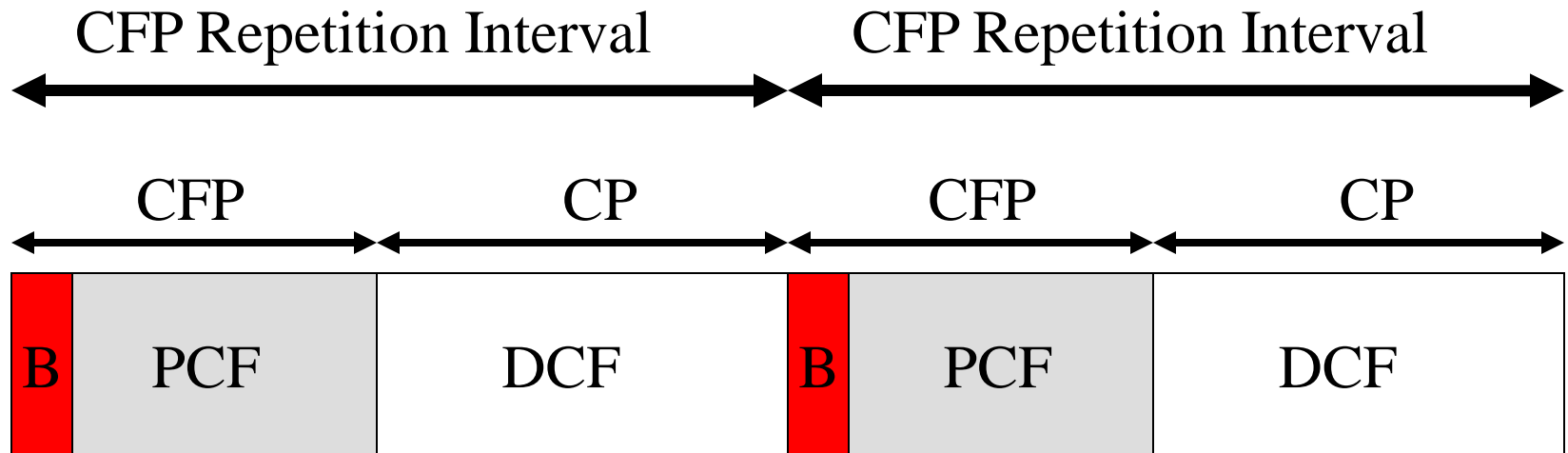



# Accessing the Wireless Medium



- Two operation modes:
  - Distributed Coordination Function (DCF)
  - Point Coordination Function (PCF)
- The coexist of DCF & PCF
- PCF & DCF tradeoff



# PCF & DCF tradeoff

---

- DCF by default, PCF is optional
- DCF cannot guarantee the transmission delay
- PCF is more suitable for QoS
- PCF needs to pay for the overhead (Poll)



# MAC Layer Operations

---

- Accessing the wireless medium
- **Joining the network**
- Providing authentication and privacy



# Startup/Join the network

- Turn on → discovery phase
  - determine AP or other stations exist
- If exist → join the network, get the following:
  - Service Set Id (SSID)
  - Timing Synchronization Function (TSF)
  - Timer Value
  - PHY setup parameters
- Negotiate for connection
  - Authentication & Association



# Discovery Phase

---

- Enter scanning mode
  - Passive / Active scanning mode
- Passive
  - Listen for a Beacon for ChannelTime period
  - In Beacon → get the SSID & parameters
- Active
  - Transmit a **probe frame** (including the SSID that wishes to join)
  - Wait for a period responded by AP or other stations



# 802.11 Station Authentication

