



Multiprotocol Label Switching (MPLS)

รศ.ดร. อนันต์ ผลเพิ่ม

Asso. Prof. Anan Phonphoem, Ph.D.

anan.p@ku.ac.th

<http://www.cpe.ku.ac.th/~anan>

Computer Engineering Department

Kasetsart University, Bangkok, Thailand



Outline

- Motivation
- MPLS Basics
- Operation
- Protocol Stack Architecture
- Advantages and Disadvantages



Motivation

- IP
- ATM
- MPLS positioning



Internet Protocol (IP)

- IP is here and everywhere
- De facto protocol for global Internet
- Disadvantages
 - connectionless (e.g. no QoS)
 - independent forwarding decisions based on IP
 - large IP header (at least 20 bytes)
 - routing in Network Layer (Slower than Switching)
 - Usually shortest path (not concern other metrics)



Asynchronous Transfer Mode (ATM)

Packet Sizes in the Network

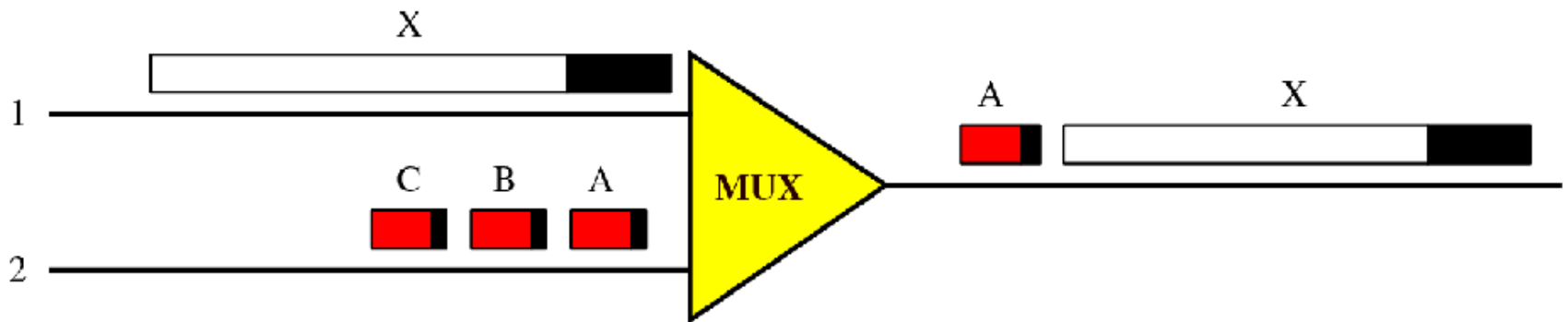

- traffic unpredictable
- Slow and expensive
- Delay variation



Voice Transmission

- If introduce large packet size for voice
 - Cannot tolerate long delay, large jitter
 - Echo problem
 - echo cancellation does not work (long delay)
- To support voice
 - Small packet
 - fixed-size packet
 - Called "**Cell**" → ***ATM cell***

Multiplexing using cells

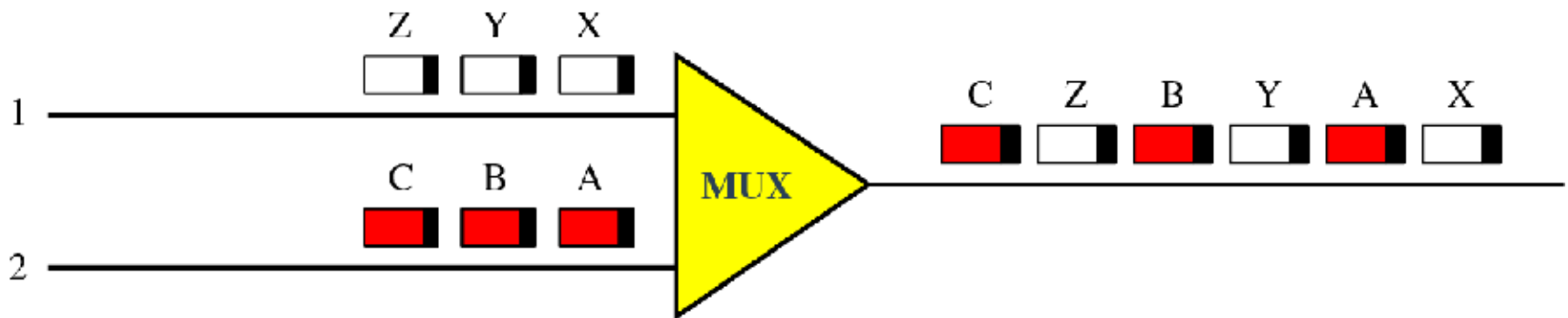

Advantages of cells

- Fair delay
- high speed and cheap (switching and multiplexing -> HW)

An ATM cell

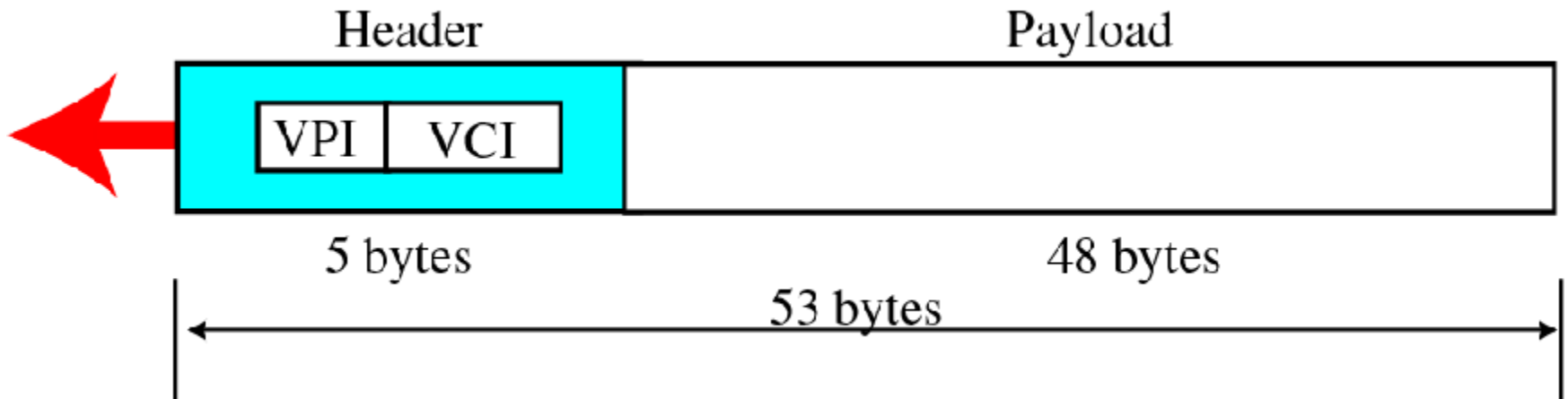

VPI: Virtual Path Identifier
VCI: Virtual Circuit Identifier

TP, VPs, and VCs

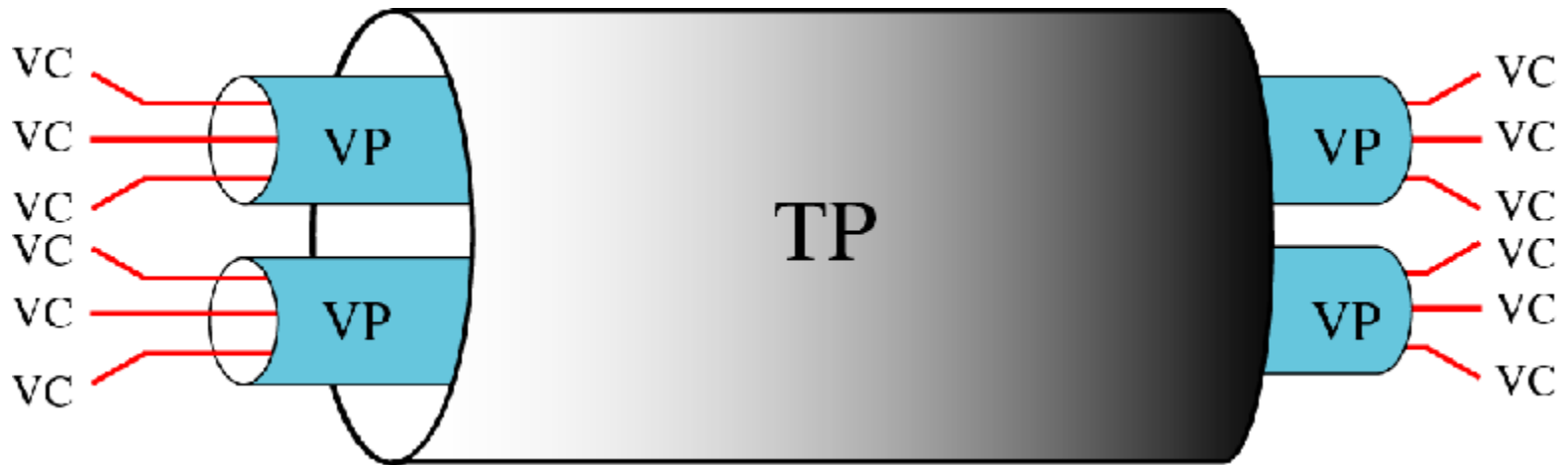

TP: Transmission Path

VP: Virtual Path

VC: Virtual Circuit

Examples of VPs and VCs

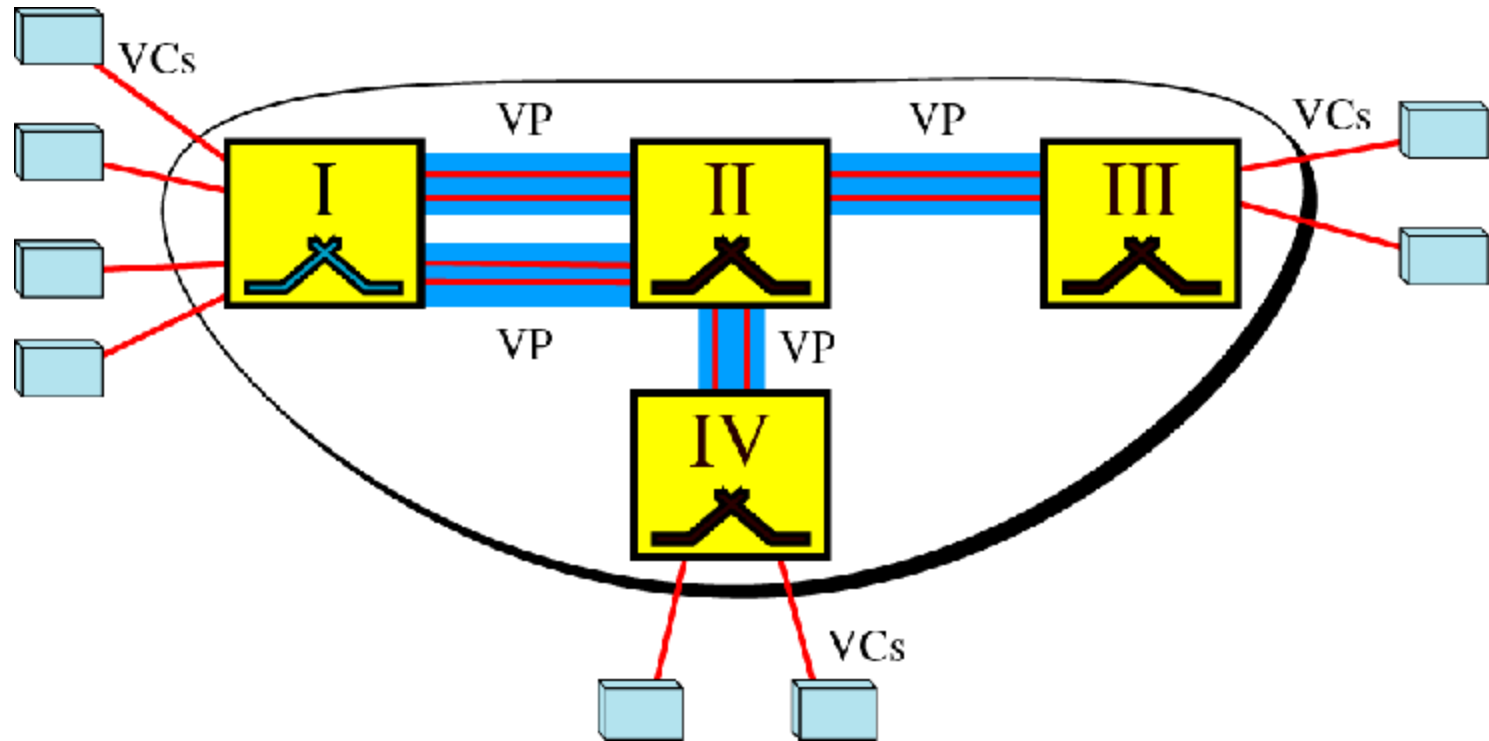

ATM Switching

Forwarding Table

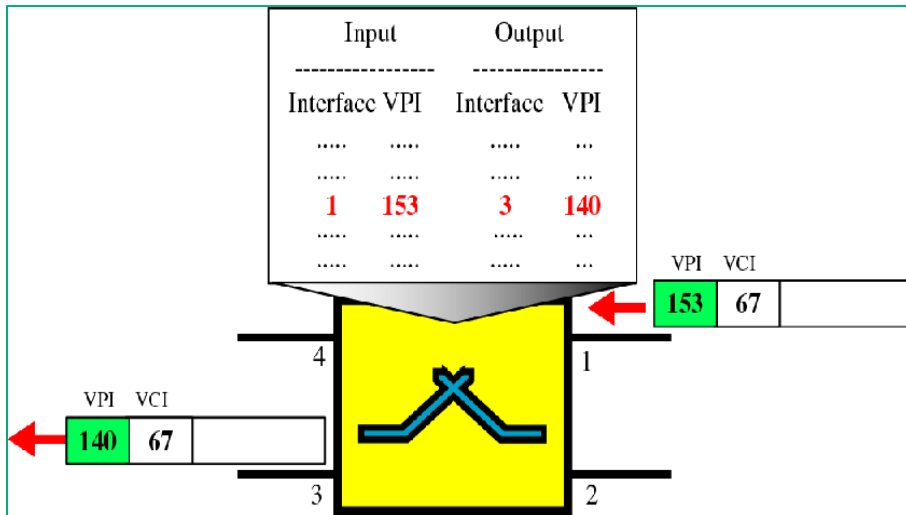

VP switch (use only VPI)
* Most switches

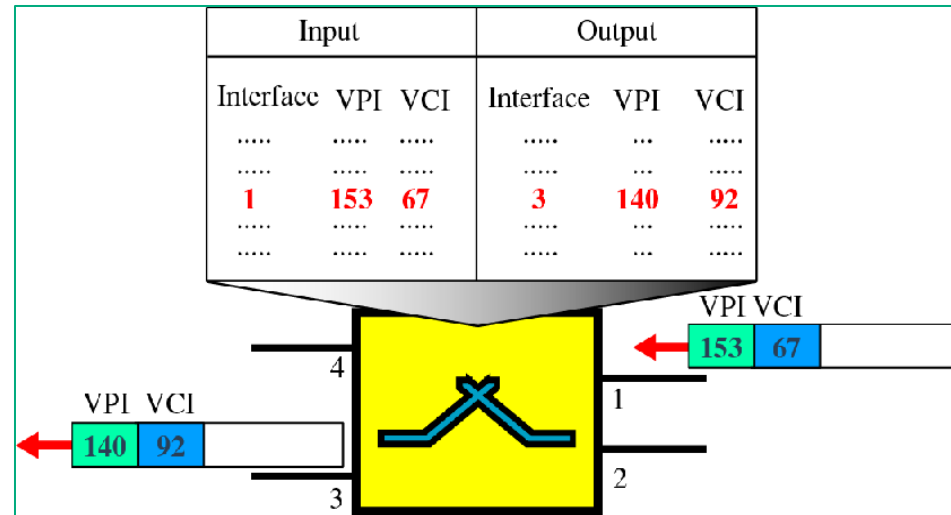

VPC switch (use both VPIs and VCIs)
* Boundaries switches



ATM

- Connection oriented (Supports QoS)
- Fast packet switching
 - fixed length packets (cells)
- Integration of different traffic types
 - voice, data, video
- Disadvantages
 - Complex
 - Expensive
 - Not widely adopted

MPLS Positioning

- Combine the forwarding algorithm used in ATM with IP

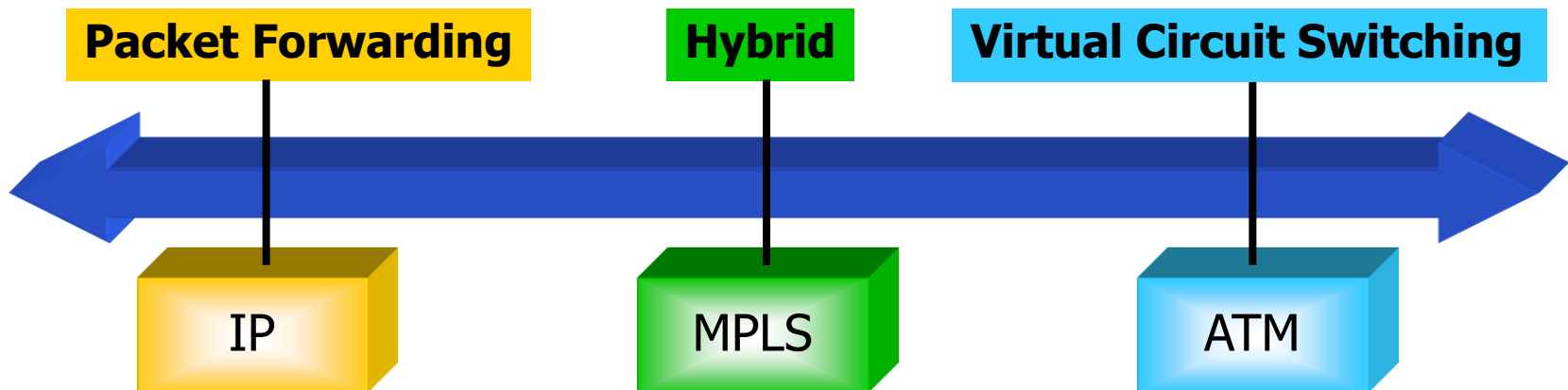



MPLS Overview

- Switch data according to its **Label (tag)**
 - look up in table
 - determine next hop
 - substitute new label
- Do not pay attention to
 - network and transport protocols
 - → **Multiprotocol**
- Switching for IP and non-IP
- Signaling protocol based on IP



Outline

- Motivation
- **MPLS Basics**
- Operation
- Protocol Stack Architecture
- Advantages and Disadvantages

MPLS in the protocol stack

- Between Layer 2 and Layer 3

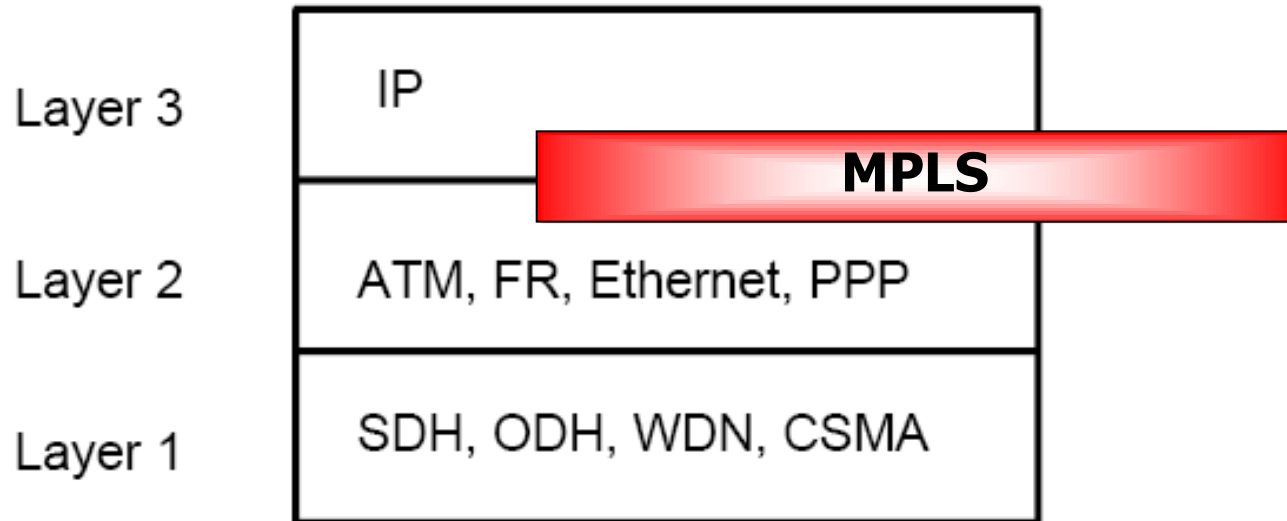



MPLS Characteristics

- Flow Management
- Independent of L2 and L3 protocols
- Maps IP-addresses to fixed length labels
- Interfaces to existing routing protocols (RSVP, OSPF)
- Supports ATM, Frame-Relay and Ethernet

Label

■ Generic label format

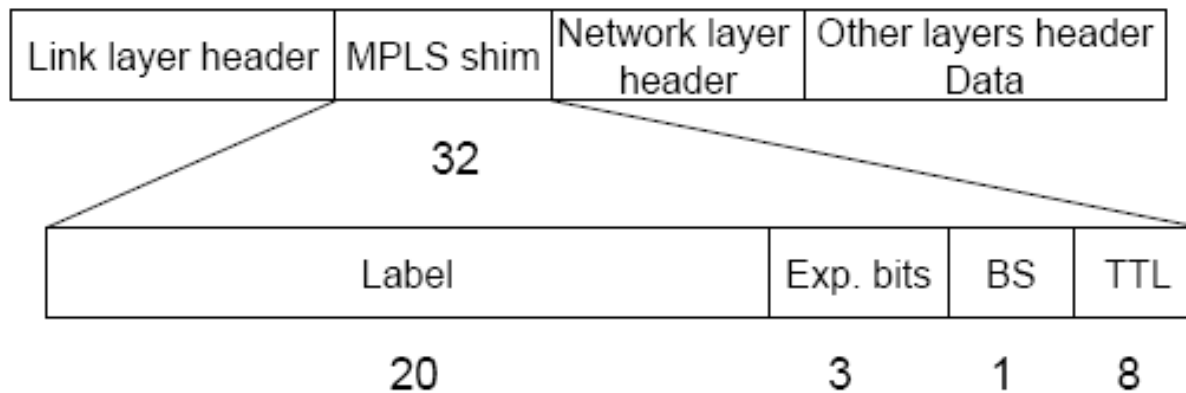

Exp.bits: Experimental Bits, often used for Class of Service

BS: Bottom of Stack bit, is set if no label follows

TTL: Time To Leave, used in the same way like in IP

Shim: A thin, often tapered piece of material, such as wood, stone, or metal, used to fill gaps, make something level, or adjust something to fit properly.
...<http://www.thefreedictionary.com/>



Label Distribution

- Not specify a single method for label distribution
- Routing support for label exchange
 - BGP and RSVP can piggyback the label information
- IETF defines signal and management
 - label distribution protocol (LDP)
- Extension of LDP protocol
 - support explicit routing based on QoS

Label Insertion

Data Link Frame



IEEE 802 MAC Frame



ATM Cell

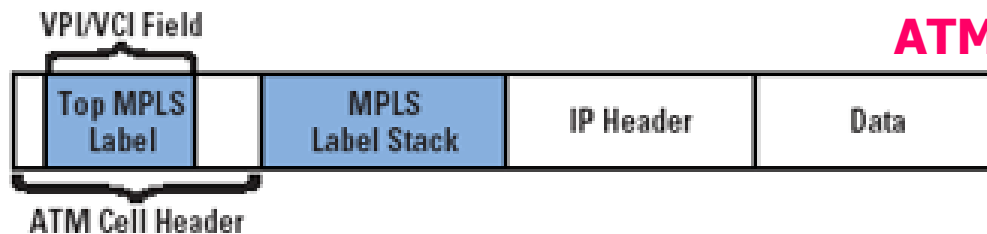

Frame Relay Frame





MPLS Terminology

LDP: Label Distribution Protocol

LSP: Label Switched Path

FEC: Forwarding Equivalence Class

LSR: Label Switching Router

LER: Label Edge Router

Label Edge Router (LER)

- Edge of an MPLS network
- Assigns and removes packet labels
- Support multiple ports
 - frame relay
 - ATM
 - Ethernet
 - etc.

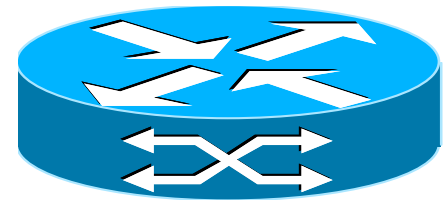

Label Switching Router (LSR)

- High speed router in the core on an MPLS network
- ATM switches can be used as LSR
 - no hardware modification
 - label switching is equivalent to VP and VC switching

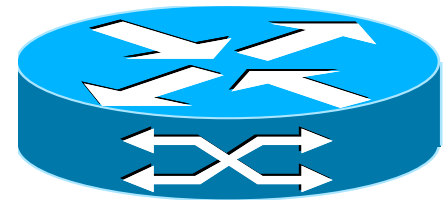

LER and LSR Position

LSP (Label Switched Path)

LER

LSR

LSR

LER

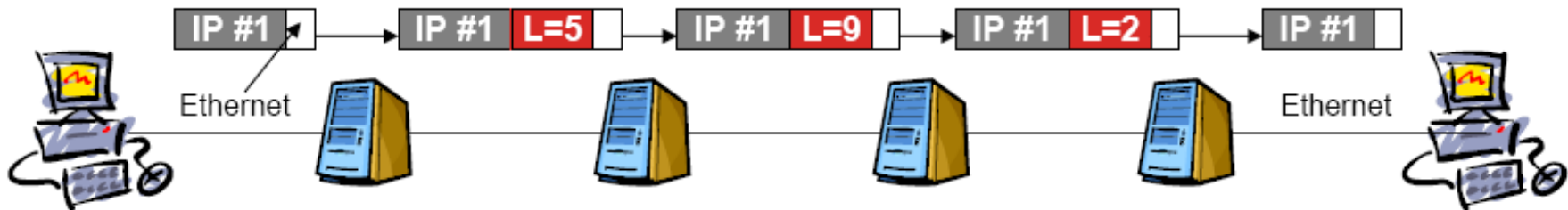

IP Addr	Out Label	In Label	Out Label	In Label	Out Label	In Label	Next Hop
192.4/16	5	5	9	9	2	2	192.4/16
Layer 2 Transport	Assign init label	Label Swapping		Label Swapping		Remove Label	Layer 2 Transport

“ROUTE AT EDGE, SWITCH IN CORE”



Forward Equivalence Class (FEC)

- Represent group of packets
 - share same requirements for their transport
- Packet Assignment
 - assignment to each packet
 - only one time at entry point



Label-Switched Path (LSP)

- A path is established before the data transmission starts
- A path is a representation of a Forward Equivalence Class (FEC)



LSP Setup

- Hop-by-hop routing
 - each LSR independently selects next hop for a given FEC
- Explicit routing
 - similar to *source routing* (sender specify the route of the packet)
 - ingress LSR specifies the list of nodes through which the packet traverses
- LSP setup for an FEC is unidirectional
 - return traffic must use another LSP



Label Distribution Protocol (LDP)

- Application layer protocol
 - for label binding distribution info to LSRs
 - map FECs to labels (create LSP)
 - LDP sessions are established between LDP peers in the MPLS network (not necessarily adjacent).
 - Sometimes employs OSPF or BGP



LDP message types

- Discovery messages
 - announce/maintain the presence of an LSR
- Session messages
 - establish/maintain/terminate sessions between LDP peers
- Advertisement messages
 - create, change, and delete label mappings for FECs
- Notification messages
 - provide advisory info and signal error information



Outline

- Motivation
- MPLS Basics
- **Operation**
- Protocol Stack Architecture
- Advantages and Disadvantages

Route at Edge, Switch in Core

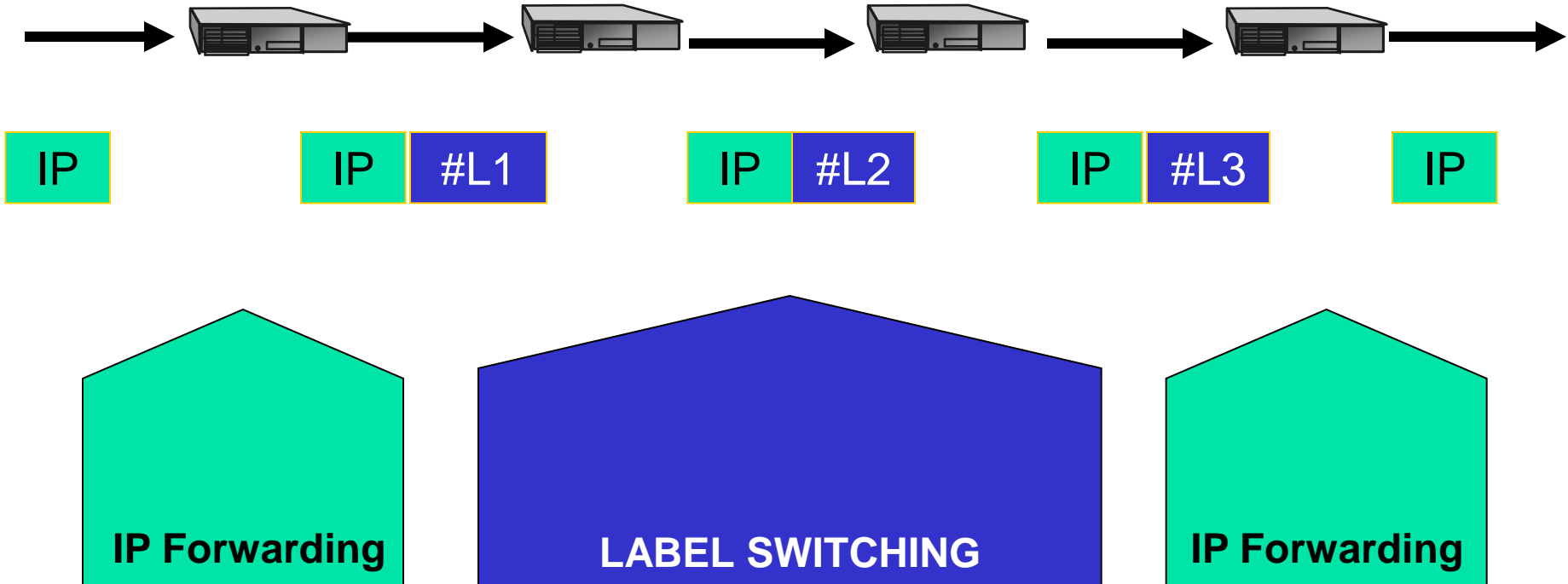

MPLS: How does it work?

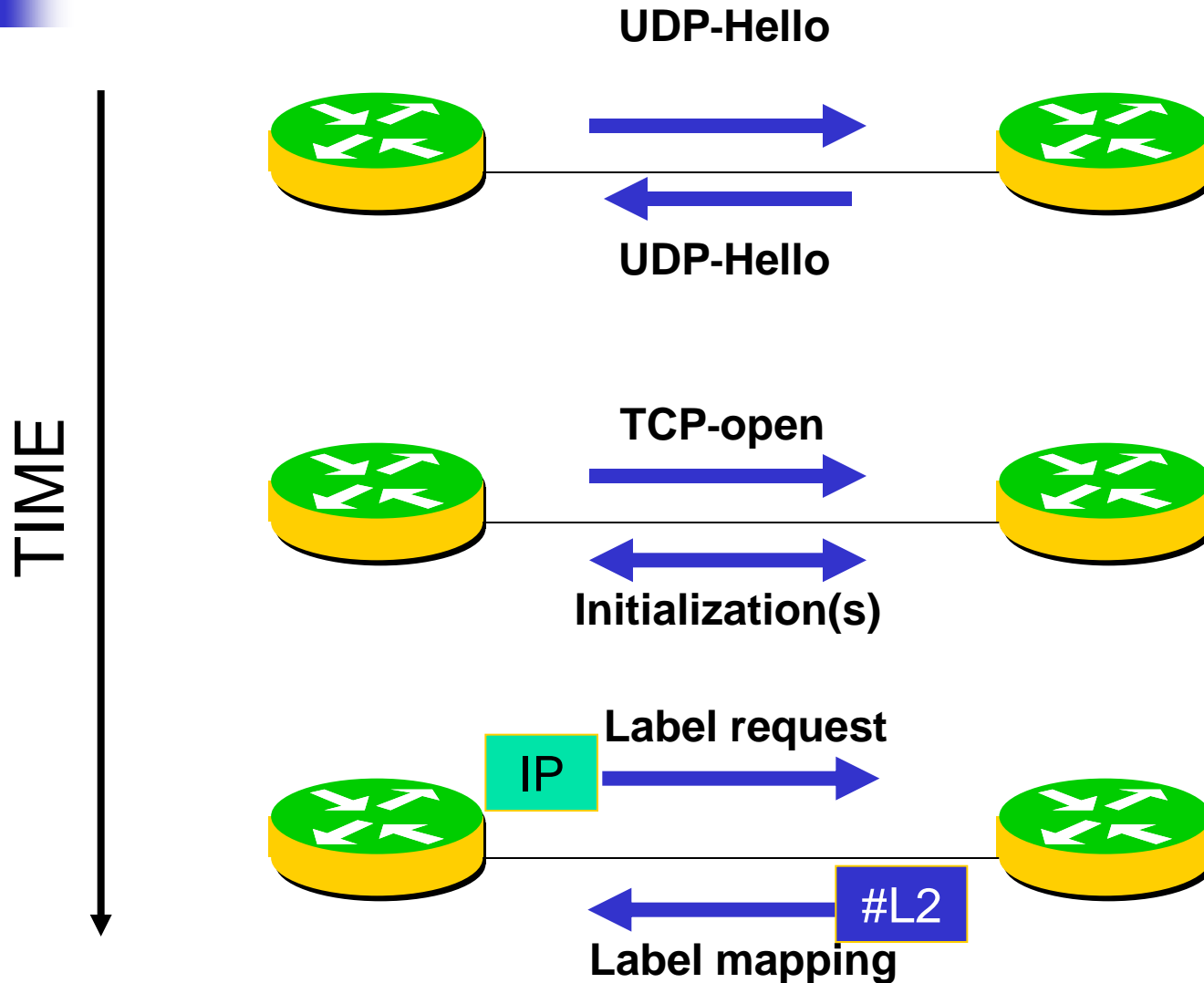



MPLS Operation

- Five Steps
 - label creation and distribution
 - table creation at each router
 - label-switched path creation
 - label insertion/table lookup
 - packet forwarding



Step 1 :Label creation and distribution

- First, routers bind a label to a specific FEC
- Then build their tables
- Using LDP
 - downstream routers initiate the distribution of labels and the label/FEC binding
 - negotiate traffic-related characteristics and MPLS capabilities
- A reliable and ordered transport protocol should be used for the signaling protocol



Step 2: Table creation

- On receipt of label bindings each LSR creates entries in the **label information base (LIB)**
- Table specifies the mapping between a label and an FEC
 - mapping between the input port and input label table to the output port and output label table
 - entries are updated whenever renegotiation of label bindings occurs



Example of LIB Table

Input Port	Incoming Port Label	Output Port	Outgoing Port Label
1	3	3	6
2	9	1	7

MPLS Label Distribution

Intf In	Label In	Dest	Intf Out	Label Out
3	0.50	47.1	1	0.40

Intf In	Label In	Dest	Intf Out
3	0.40	47.1	1

Intf In	Dest	Intf Out	Label Out
3	47.1	1	0.50

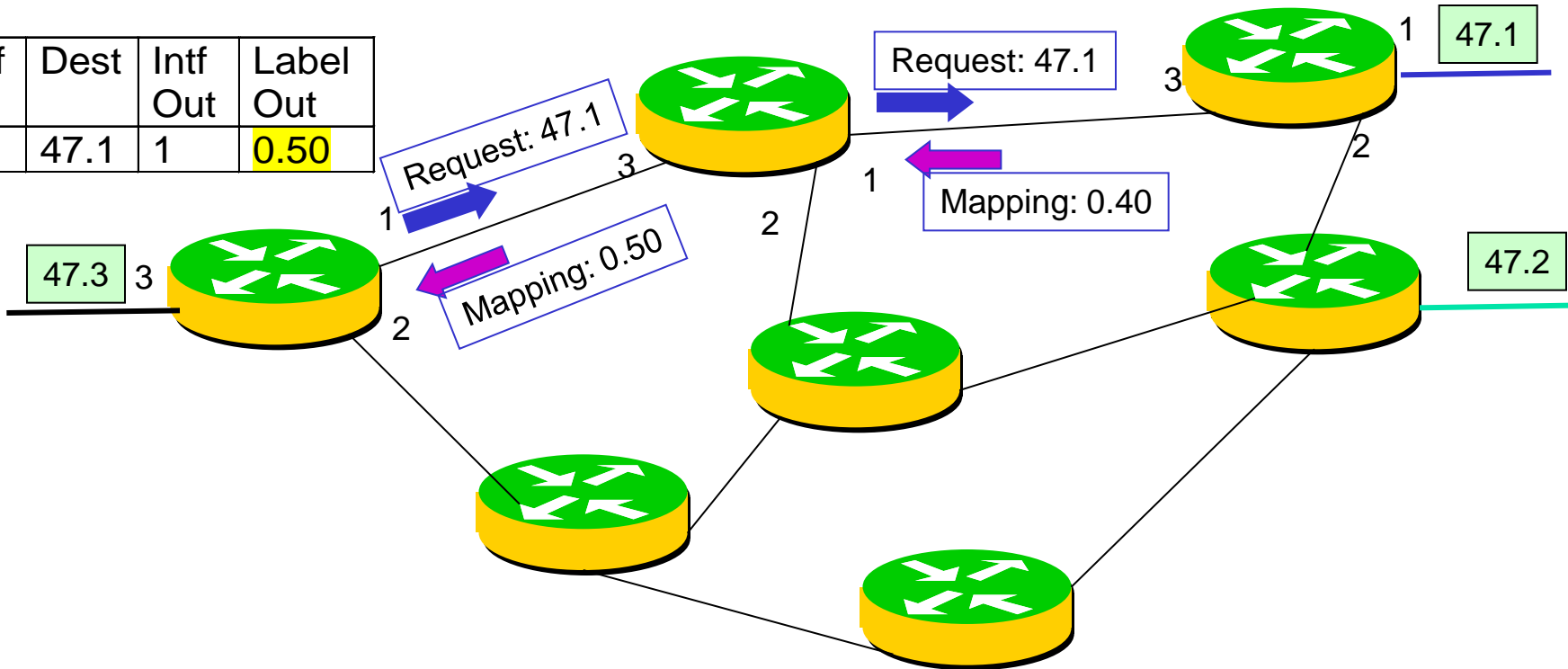

Label Switched Path (LSP)

Intf In	Label In	Dest	Intf Out	Label Out
3	0.50	47.1	1	0.40

Intf In	Label In	Dest	Intf Out
3	0.40	47.1	1

Intf In	Dest	Intf Out	Label Out
3	47.1	1	0.50

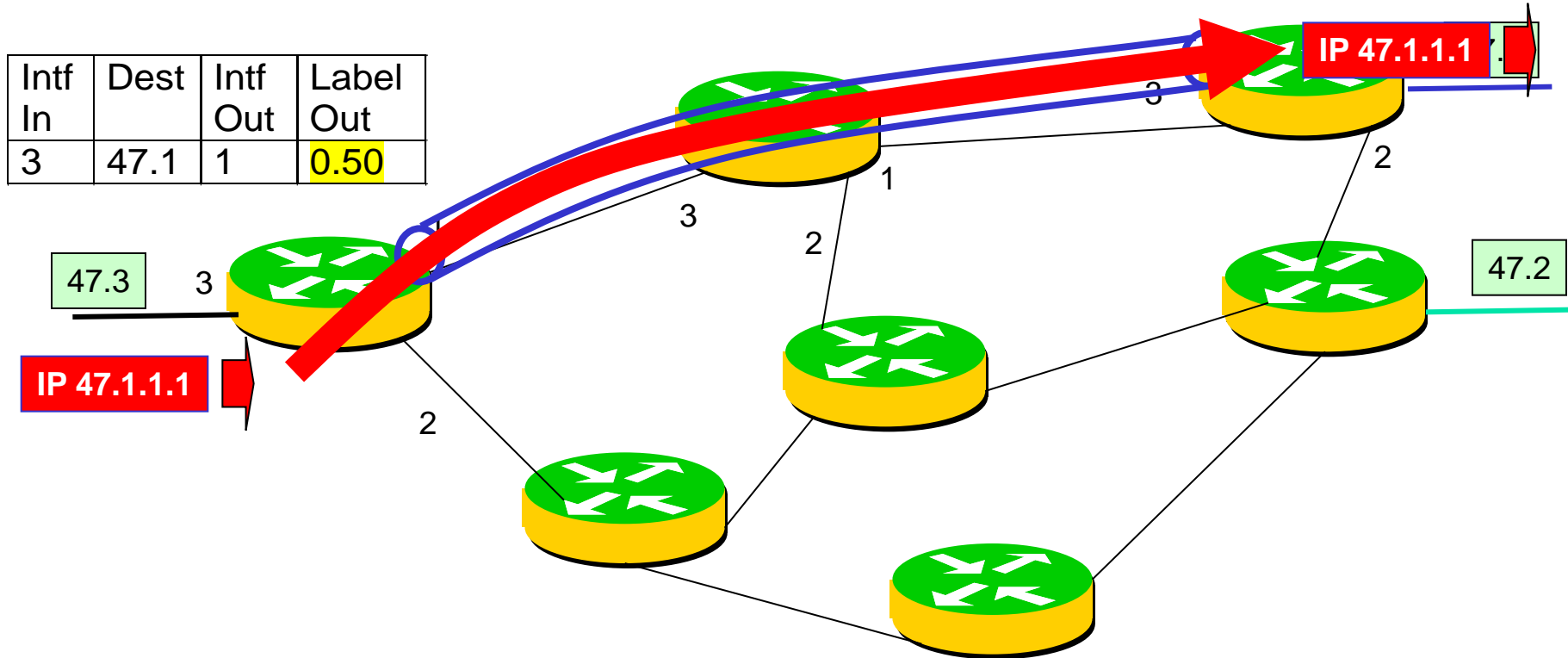



Step 3: Label switched path creation

- LSPs are created in the reverse direction to the creation of entries in the LIBs.

MPLS Example

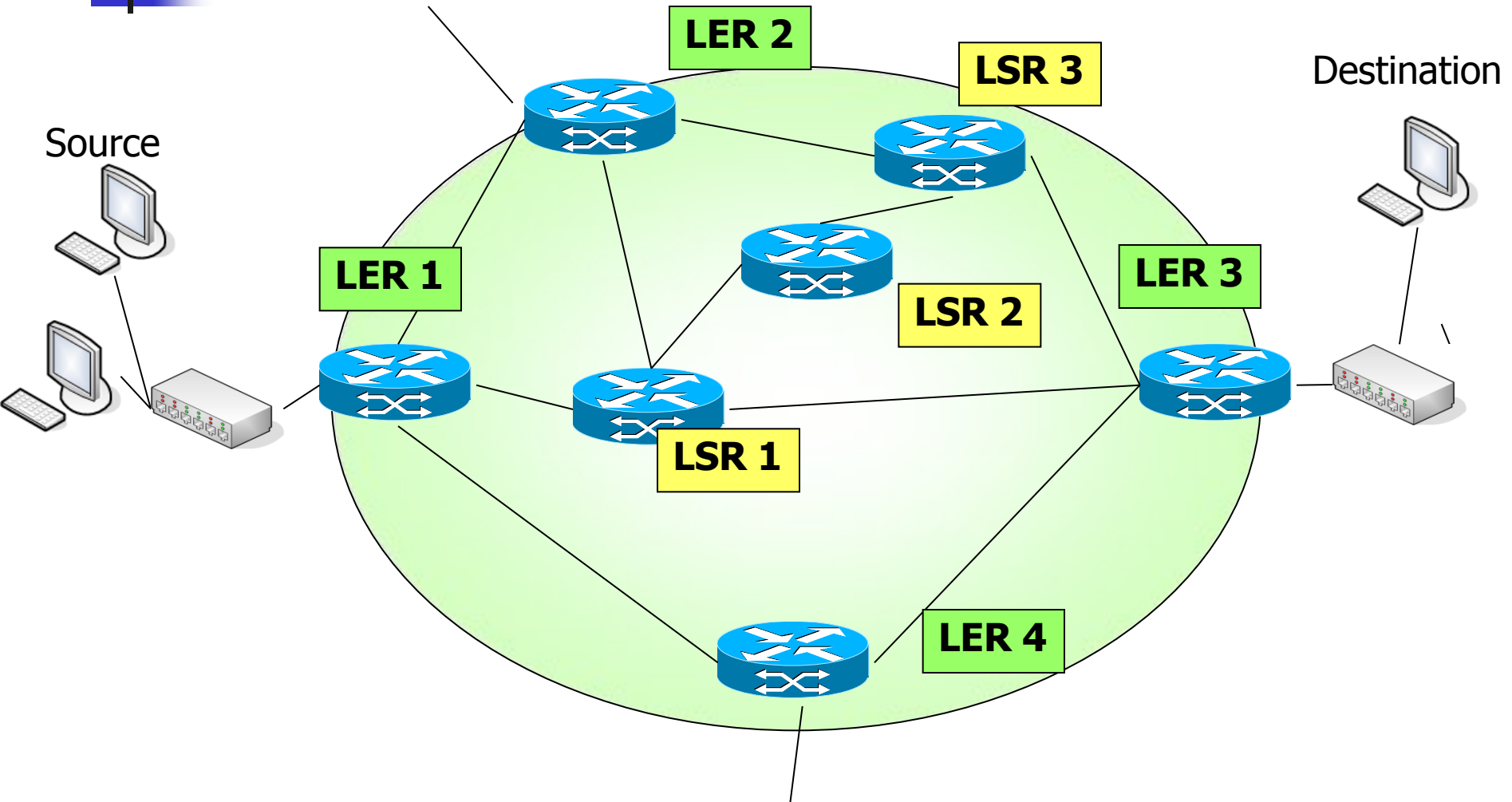



Step 4: Label insertion/table-lookup

- First router (LER1) uses LIB table to find the next hop and request a label for the specific FEC
- Subsequent routers just use the label to find the next hop
- Once the packet reaches the egress LSR (LER3), the label is removed and the packet is supplied to the destination



Step 5: Packet forwarding

- For first time packet
 - LER1 may not have any labels
 - (In IP) find the longest add match for next hop
 - Let LSR1 be the next hop for LER1.
- LER1 will initiate a label request toward LSR1
- This request will propagate through the network (green lines)

MPLS Operation Example

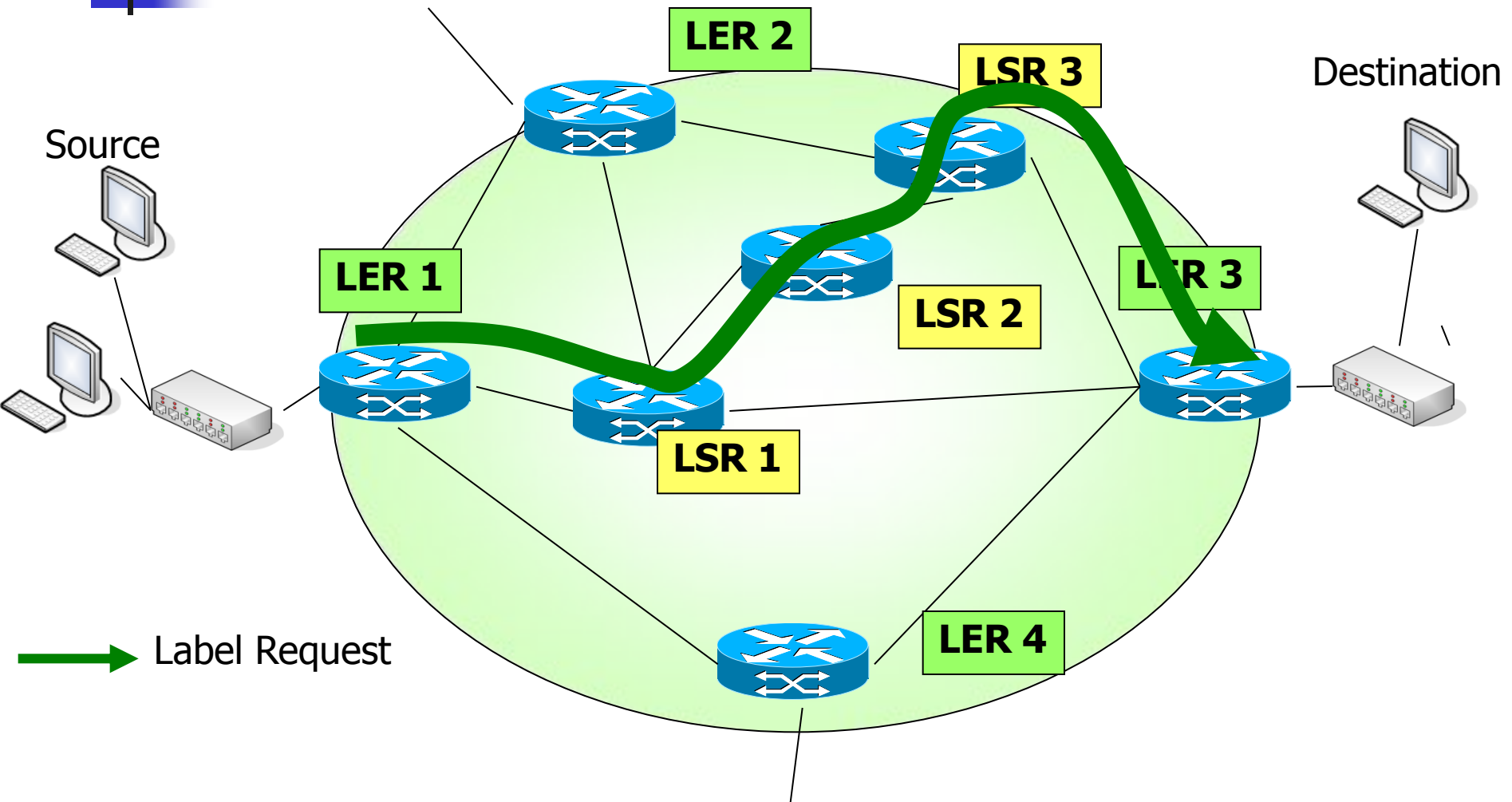



Step 5 (cont.)

- Label downstream (LER3 → LSR → ... → LER1)
- The LSP setup (blue lines) uses LDP or any other signaling protocol.
- LER1 will insert the label and forward the packet to LSR1

MPLS Operation Example

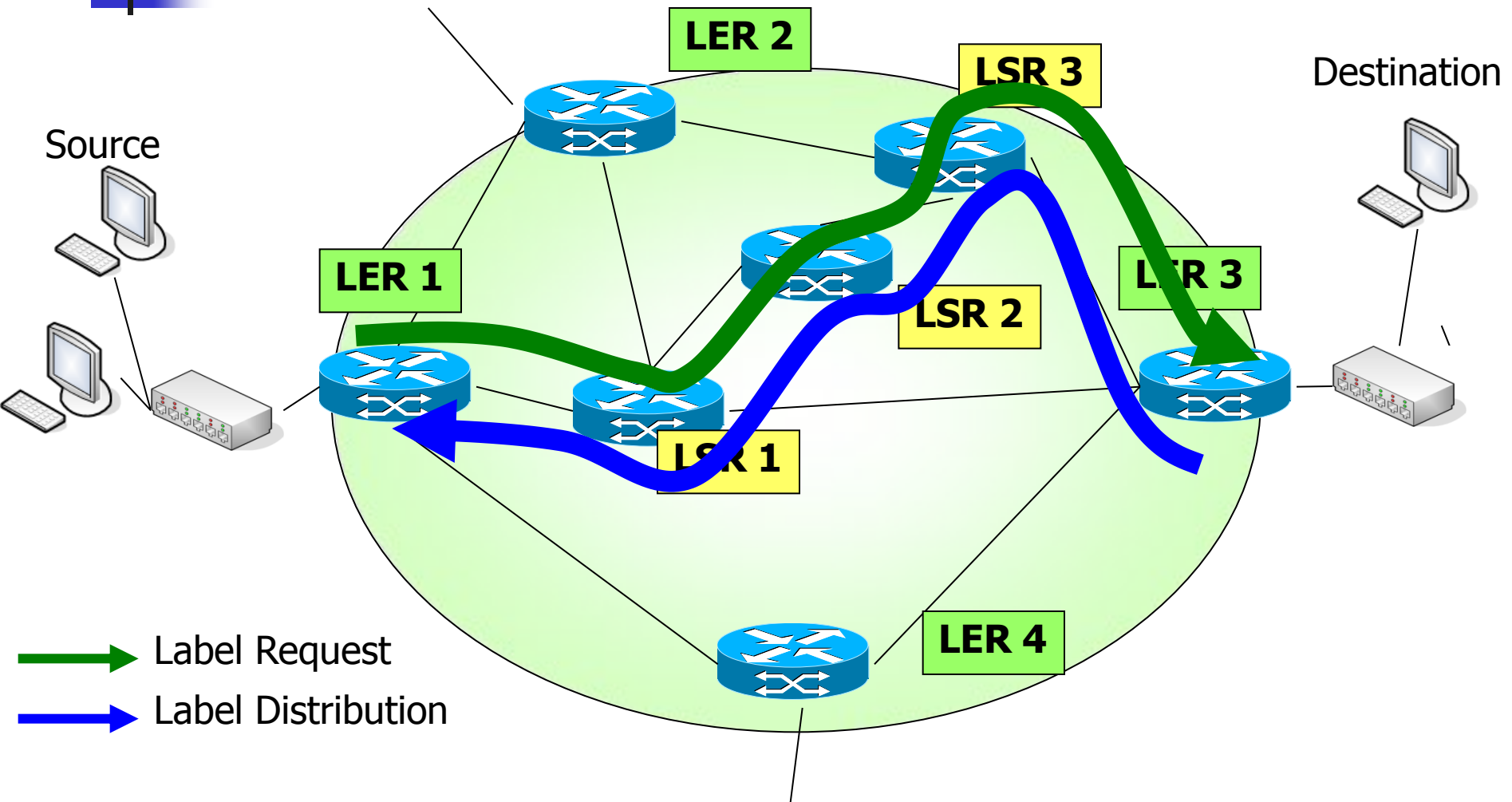



Step 5 (cont.)

- Each subsequent LSR (LSR2,LSR3)
 - examine label in received packet
 - replace it with outgoing label
 - forward it
- When reaches LER4, label is removed
 - leave MPLS domain and deliver to the destination
- Actual data path followed by the packet is the red line

MPLS Operation Example

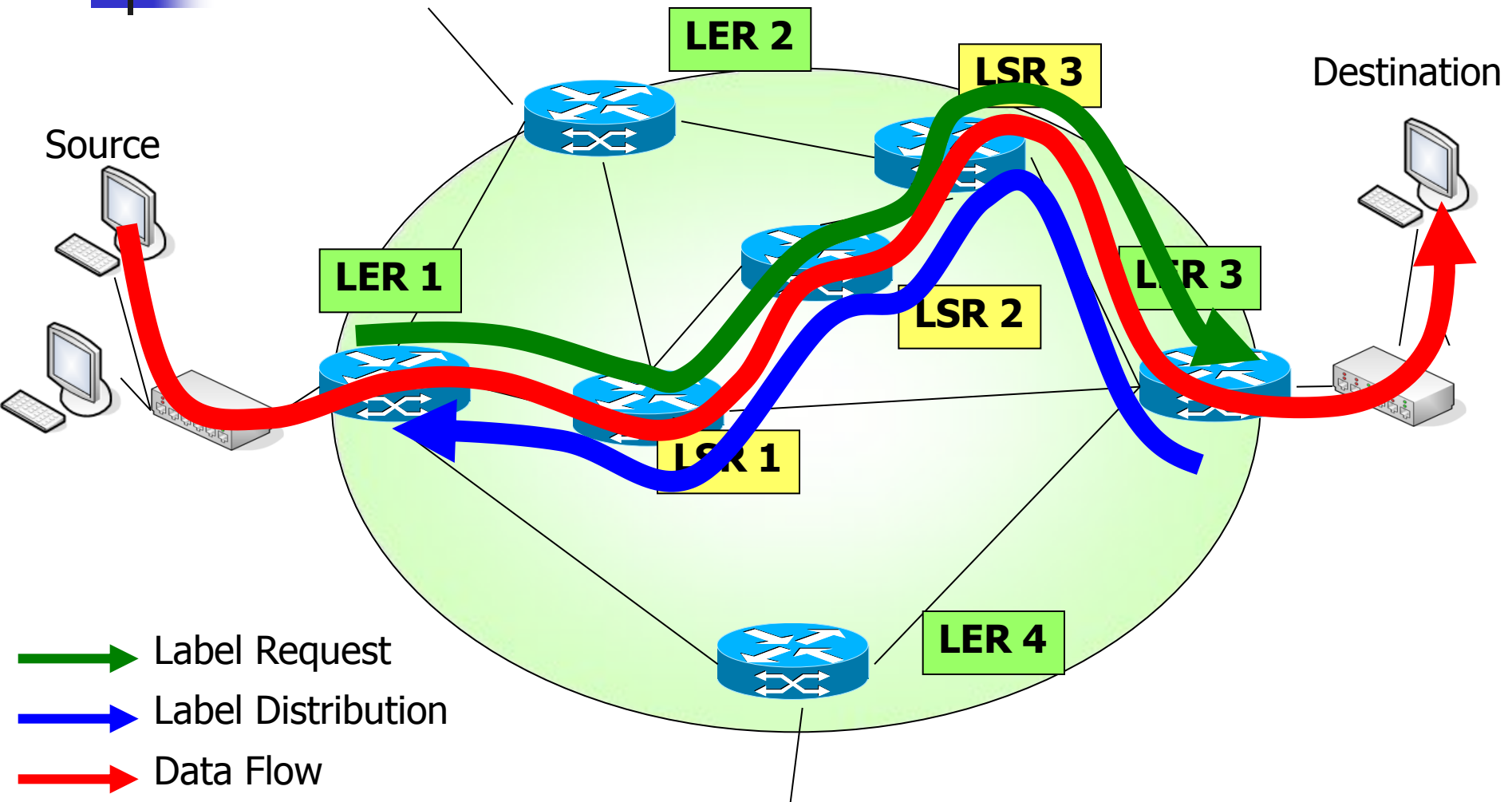



Tunneling in MPLS

- Control the entire path of a packet without explicitly specifying the intermediate routers.
 - Creating tunnels through the intermediary routers that can span multiple segments.
- MPLS based VPNs.

Tunneling in MPLS

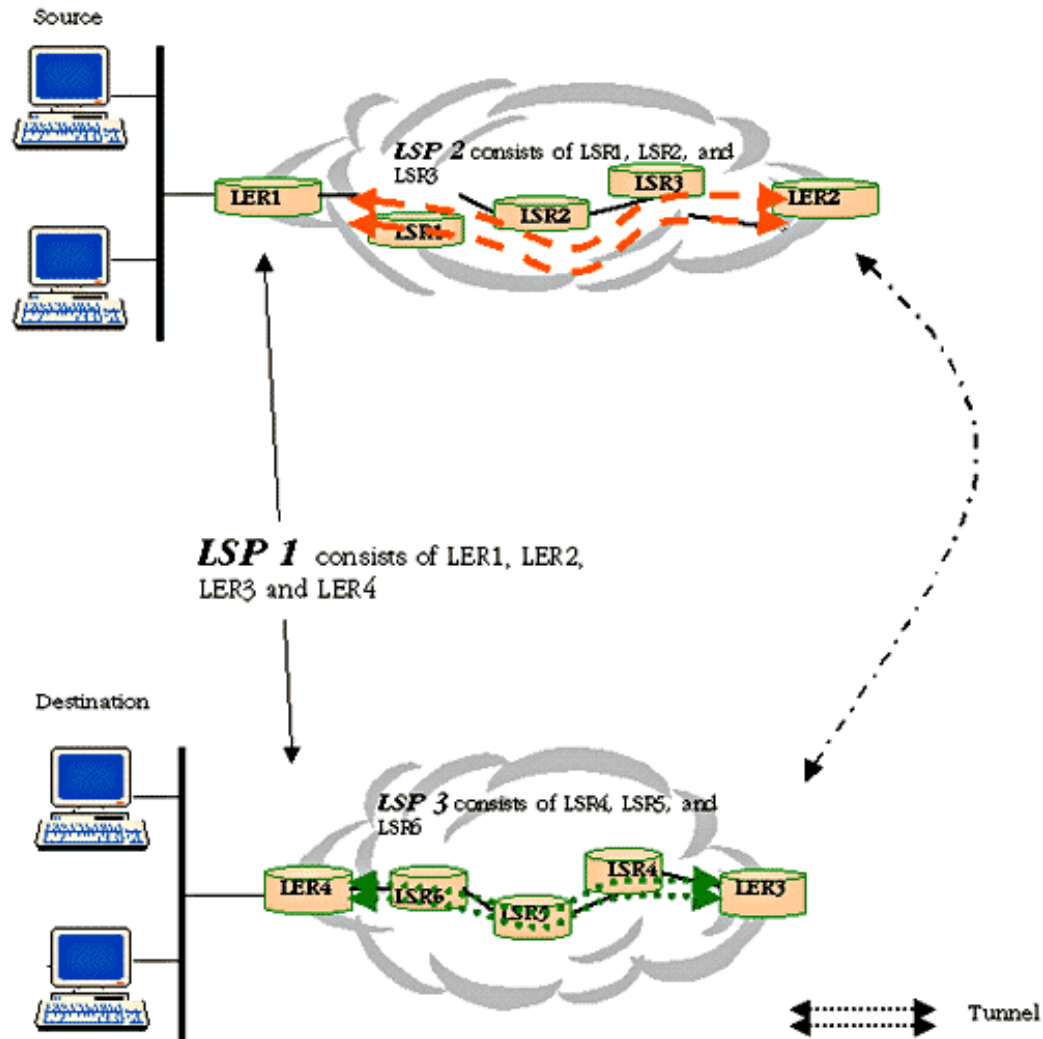



Outline

- Motivation
- MPLS Basics
- Operation
- **Protocol Stack Architecture**
- Advantages and Disadvantages

MPLS Protocol Stack Architecture

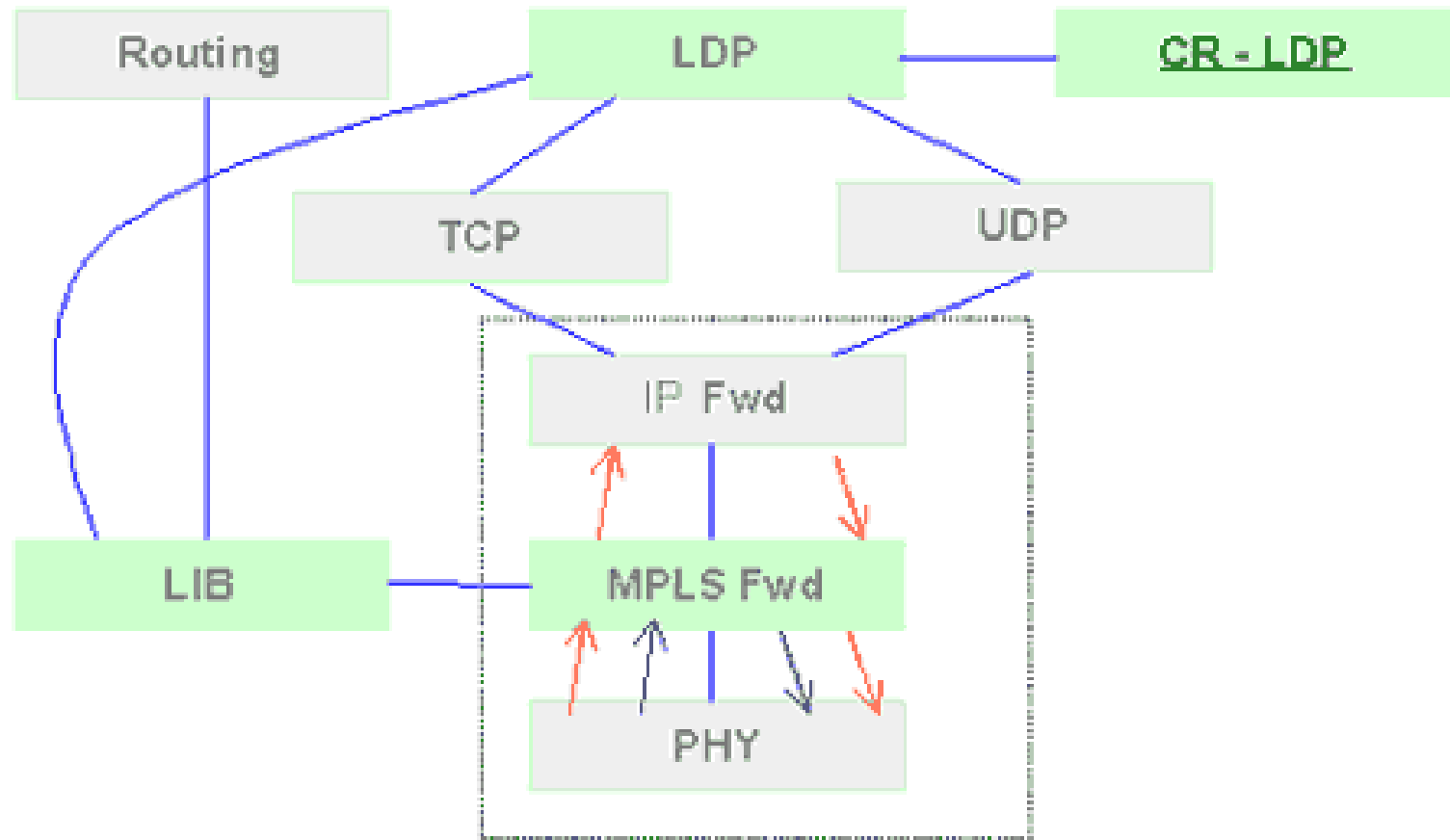



Outline

- Motivation
- Basics
- Operation
- Protocol Stack Architecture
- **Advantages and Disadvantages**



MPLS Advantages

- Improves packet-forwarding performance in the network
- Supports QoS and CoS for service differentiation
- Supports network scalability
- Integrates IP and ATM in the network
- Builds interoperable networks



MPLS Disadvantages

- An additional layer is added
- The router has to understand MPLS



References

- “MPLS Introduction”, Yun Teng, Dept. of Computer Science, UMBC
- “MPLS Tutorial and Operational Experiences”, Peter Ashwood-Smith, Bilel Jamoussi, October, 1999