

Wireless LANs

December 2011 – March 2012



IEEE 802.11 MAC

รศ. ดร. อนันต์ ผลเพิ่ม

Assoc. Prof. Anan Phonphoem, Ph.D.

anan.p@ku.ac.th

Intelligent Wireless Network Group (IWING Lab)

<http://iwing.cpe.ku.ac.th>

Computer Engineering Department

Kasetsart University, Bangkok, Thailand



MAC Layer

- **MAC Layer operation**
 - Contention & contention-free
 - Priority frame transmission
- MAC frame structure
 - Create MAC frame
- MAC frame Types
 - MAC management, control, and data frame



MAC Layer Operations

- Accessing the wireless medium
- Joining the network
- Providing authentication and privacy



Accessing Wireless Medium

- Two operation modes
 - Distributed Coordination Function (DCF)
 - Point Coordination Function (PCF)
- The coexist of DCF & PCF
- PCF & DCF tradeoff

Distributed Coordination Function (DCF)



- CSMA/CA
- Error Recovery Mechanism
- Carrier Sense Mechanism
- Access Spacing



CSMA/CD

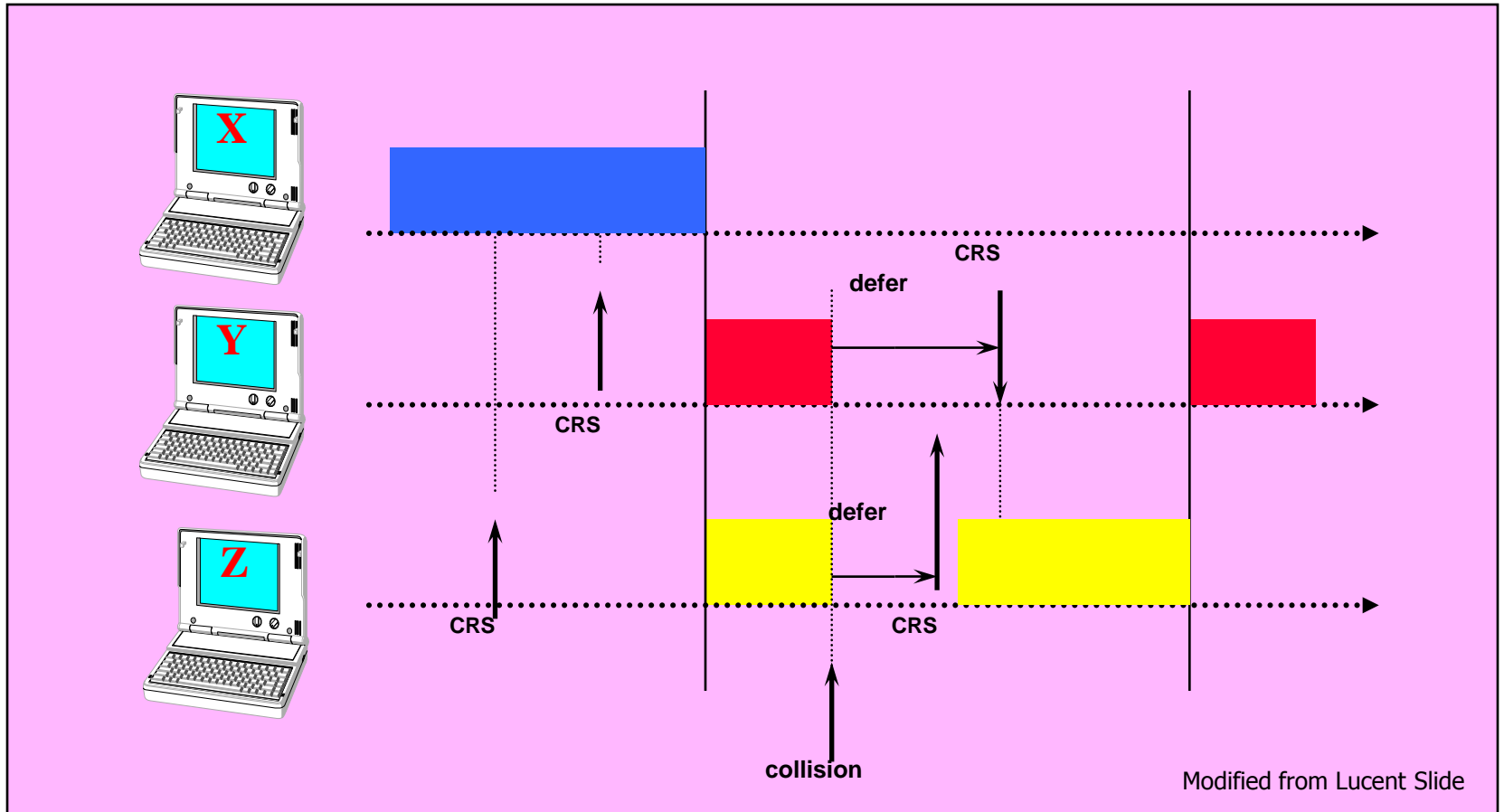



DCF - CSMA/CA

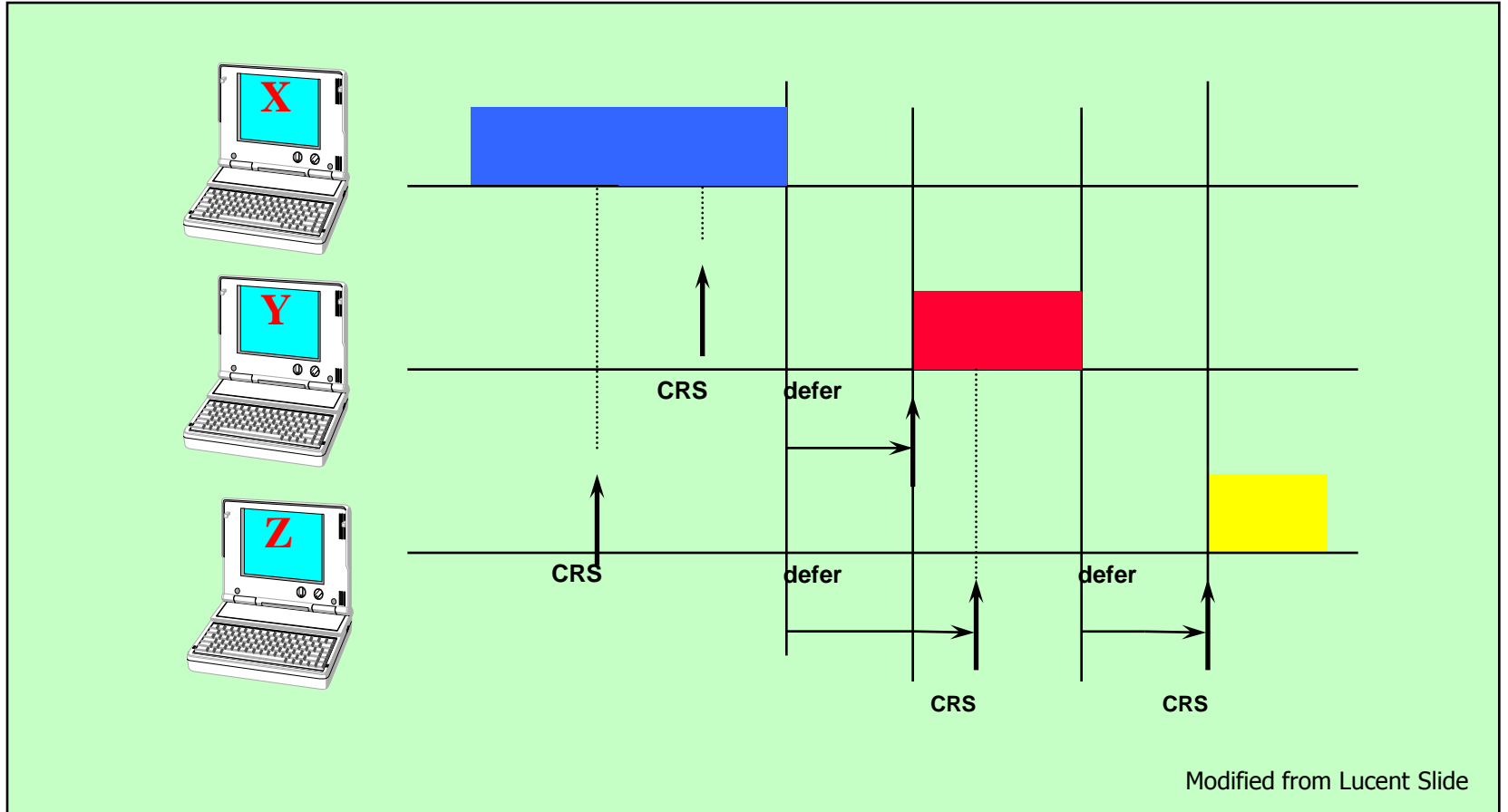



Error Recovery Mechanism

- Transmission impairments
 - Errors (interference, collision)
- Handshake mechanism
 - RTS: Request to send
 - CTS: Clear to send
 - ACK: Acknowledge
 - Data: Data Frame



Handshake Mechanism

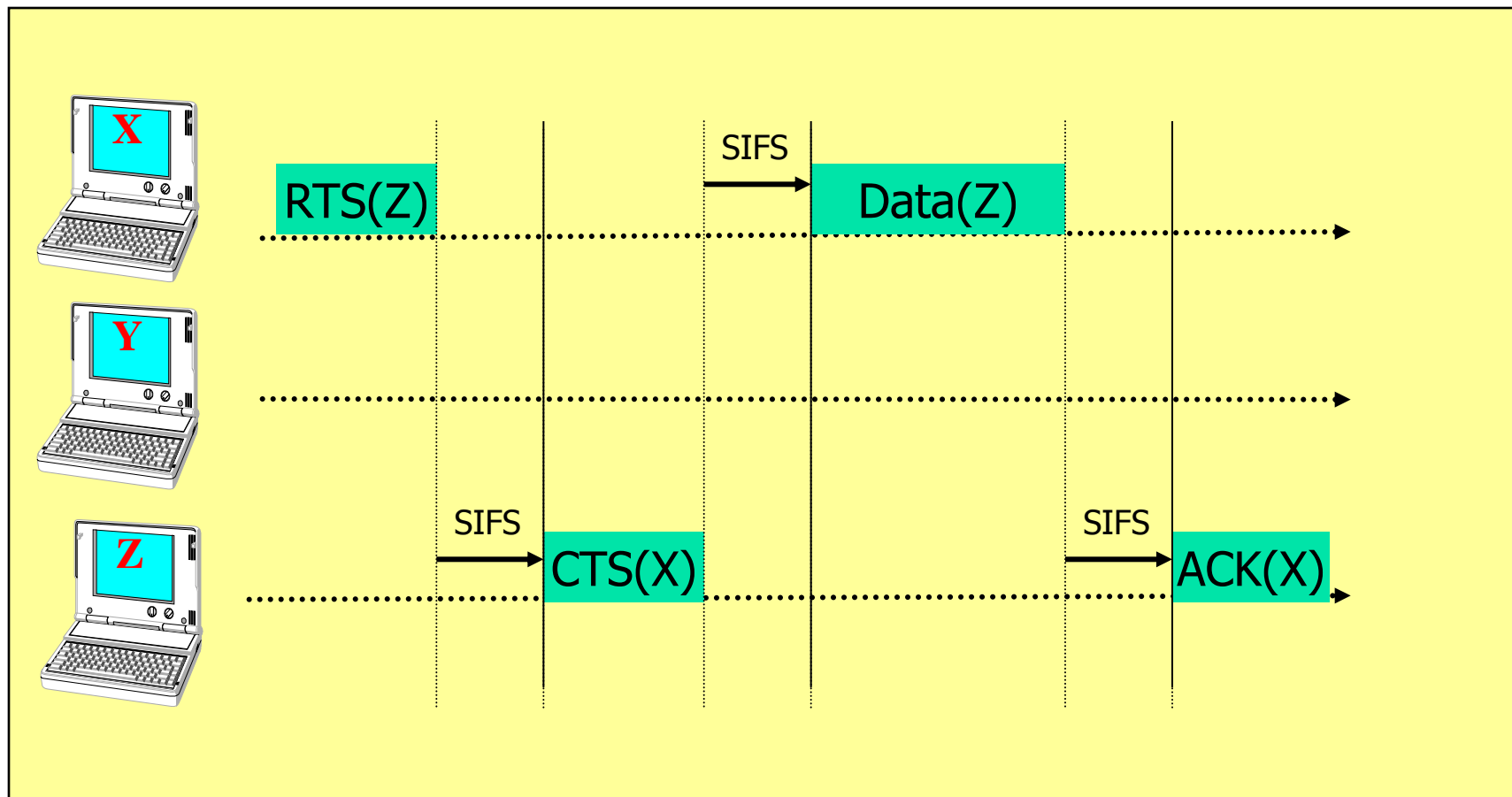



Carrier Sense Mechanism

- Check for Availability of the Medium
 - Status = Idle / Busy
- Two methods
 - Physical Carrier Sense (Physical Channel Assessment)
 - Virtual Carrier Sense (Network Allocation Vector: NAV)



Physical Carrier Sense

- Depend on the modulation techniques/medium
- Cannot Tx and Rx simultaneously (too expensive)
- Hidden nodes

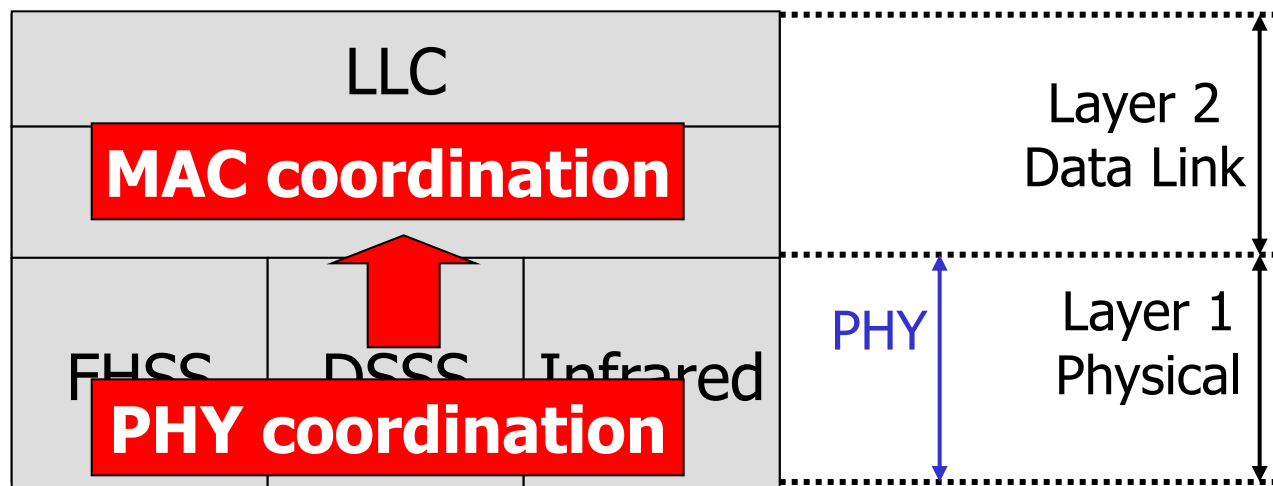



Virtual Carrier Sense

- Used “Network Allocation Vector” (NAV)
 - A timer for channel reserved period
 - Included in the RTS and CTS frames
 - Each station will count down until $NAV = 0$
 - If $NAV \neq 0 \rightarrow$ Medium is Busy
 - If $NAV = 0 \rightarrow$ Medium is idle



Virtual Carrier Sense

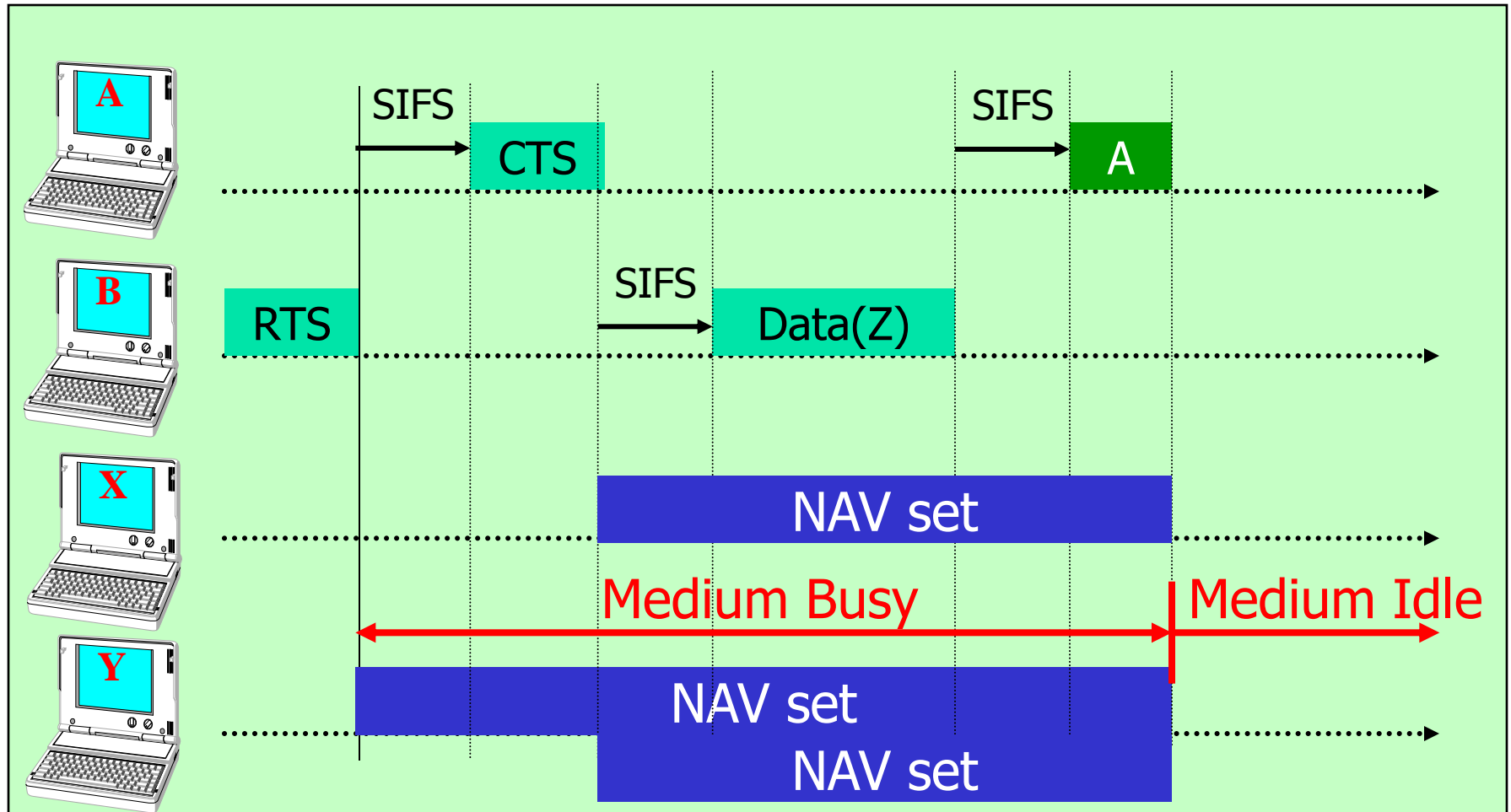



Access Spacing

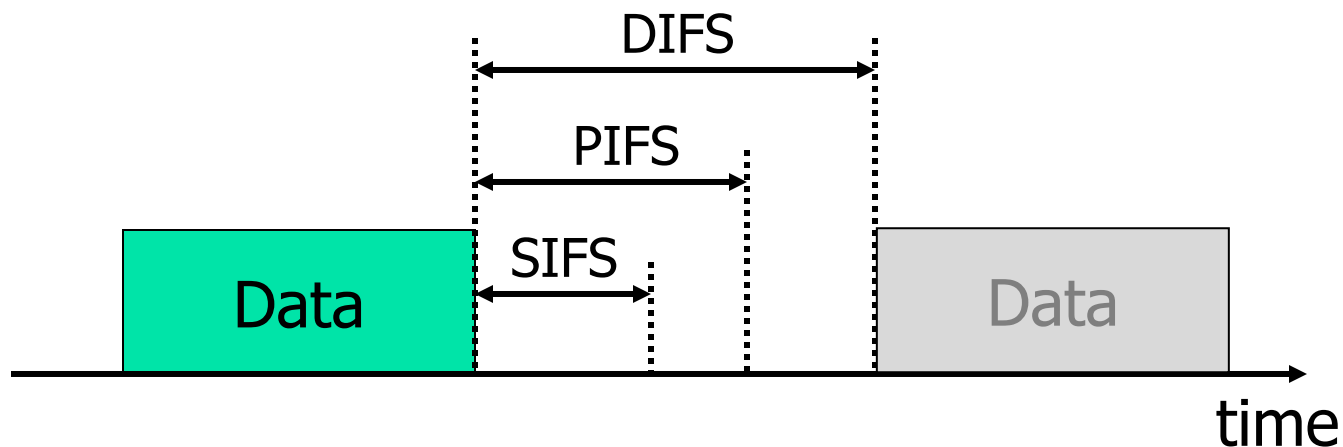

IFS	Interframe Space	Priority	Usage
SIFS	Short IFS	Highest priority	ACK, CTS, 2 nd MSDU
PIFS	PCF IFS	2 nd priority	PCF operation mode
DIFS	DCF IFS	3 rd priority	DCF operation mode
EIFS	Extended IFS	Lowest priority	Waiting period



Sending Data and Ack

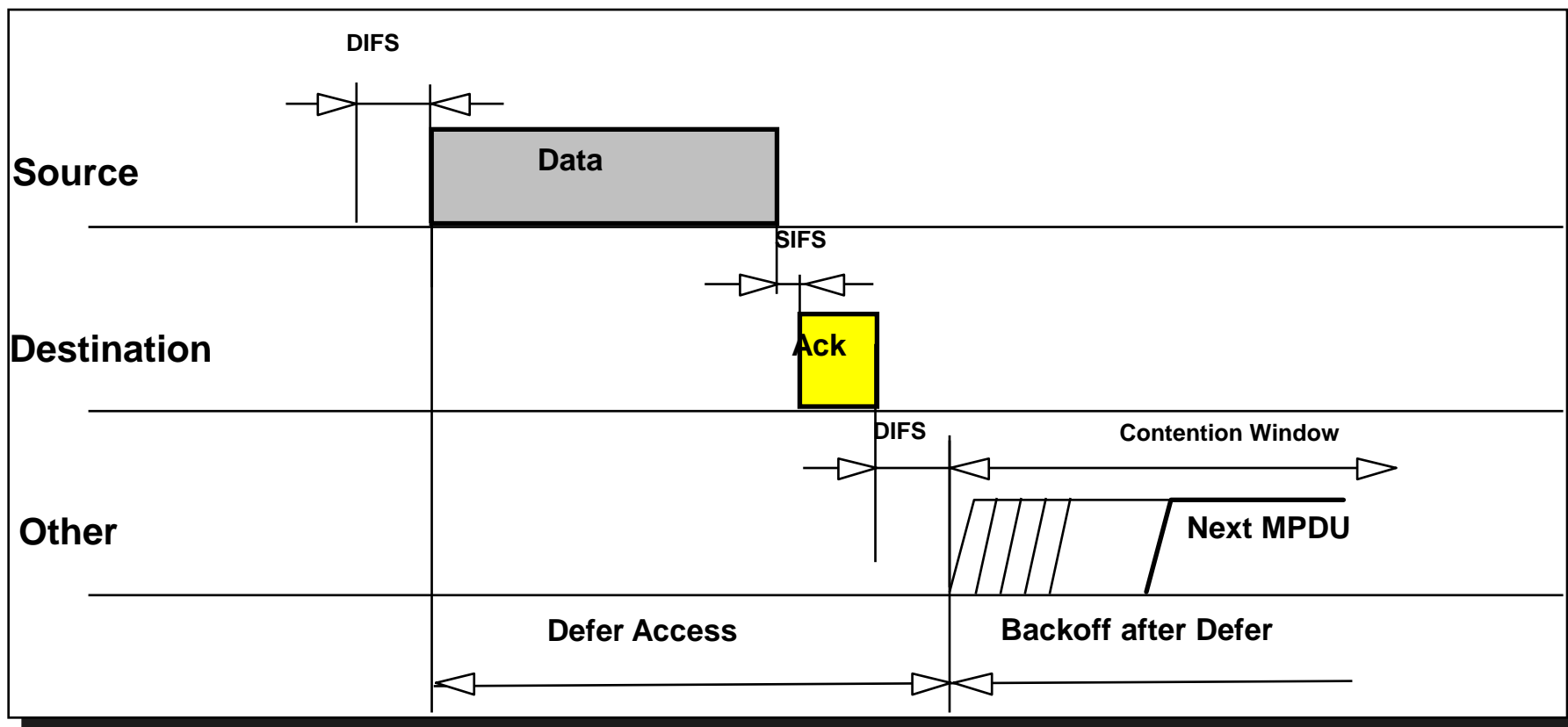



DCF Backoff

- Similar to Ethernet
- Each retry
→ window size increases
- For DSSS
 - Contention window = $2^n - 1$
 - Smallest = 31, Biggest = 1023

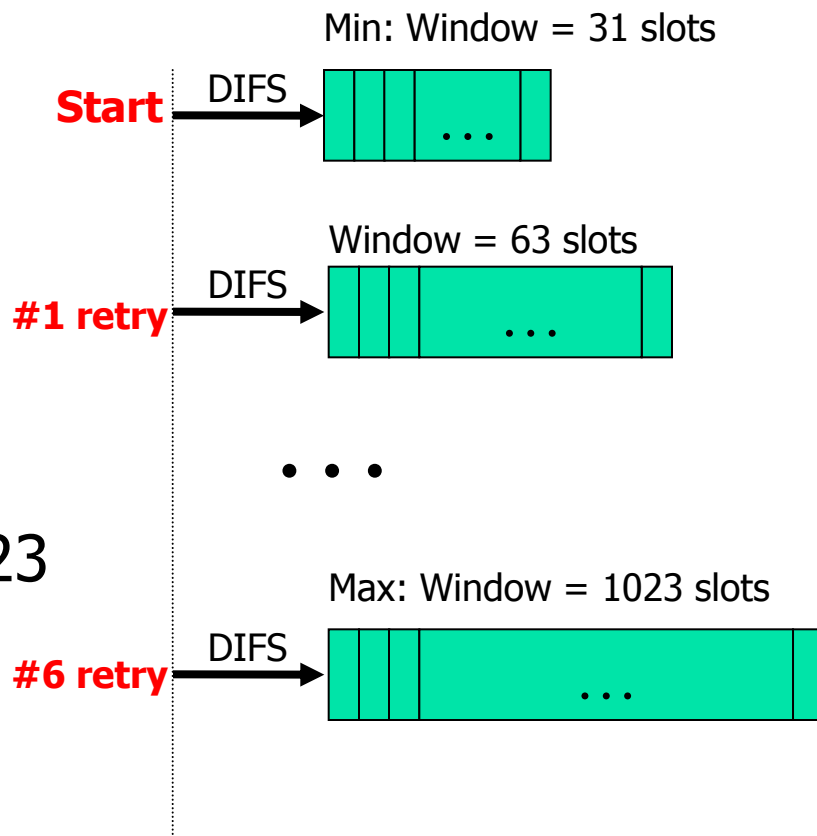



Some DCF rules

- If medium idle after DIFS
 - Tx can begin
 - If no error → medium must be free for DIFS
 - If error → medium must be free for EIFS
- If medium Busy
 - Defer Access
- Positive ACK is required (For unicast)



Accessing Wireless Medium

- Two operation modes:
 - Distributed Coordination Function (DCF)
 - Point Coordination Function (PCF)
- They coexist of DCF & PCF
- PCF & DCF tradeoff



Point Coordination Function (PCF)

- Priority-based \rightarrow QoS
- Contention-free frame transfer
- Optional



PCF operation

- Point Coordinator (PC) takes control the medium
 - Sense the medium @ beginning of PCF period
 - If idle after PIFS interval, sends Beacon frame
 - Beacon includes CF parameters (CFPMaxDuration : length of CF period)
- All stations receive Beacon:
 - Update NAV with the CFPMaxDuration
 - Cannot take control the medium until CF period end



PCF operation

- After SIFS interval, PC may transmit
 - Data frame (PC → station)
 - Individual, broadcast, multicast
 - Immediate retransmit is allowed (PIFS)
 - CF Poll frame
 - Grants permission to stations
 - Can transmit to any destination
 - Only single frame allowed per poll
 - Data + CF Poll frame (piggyback)
 - CF End frame
 - Announce the end of CF period



PCF operation

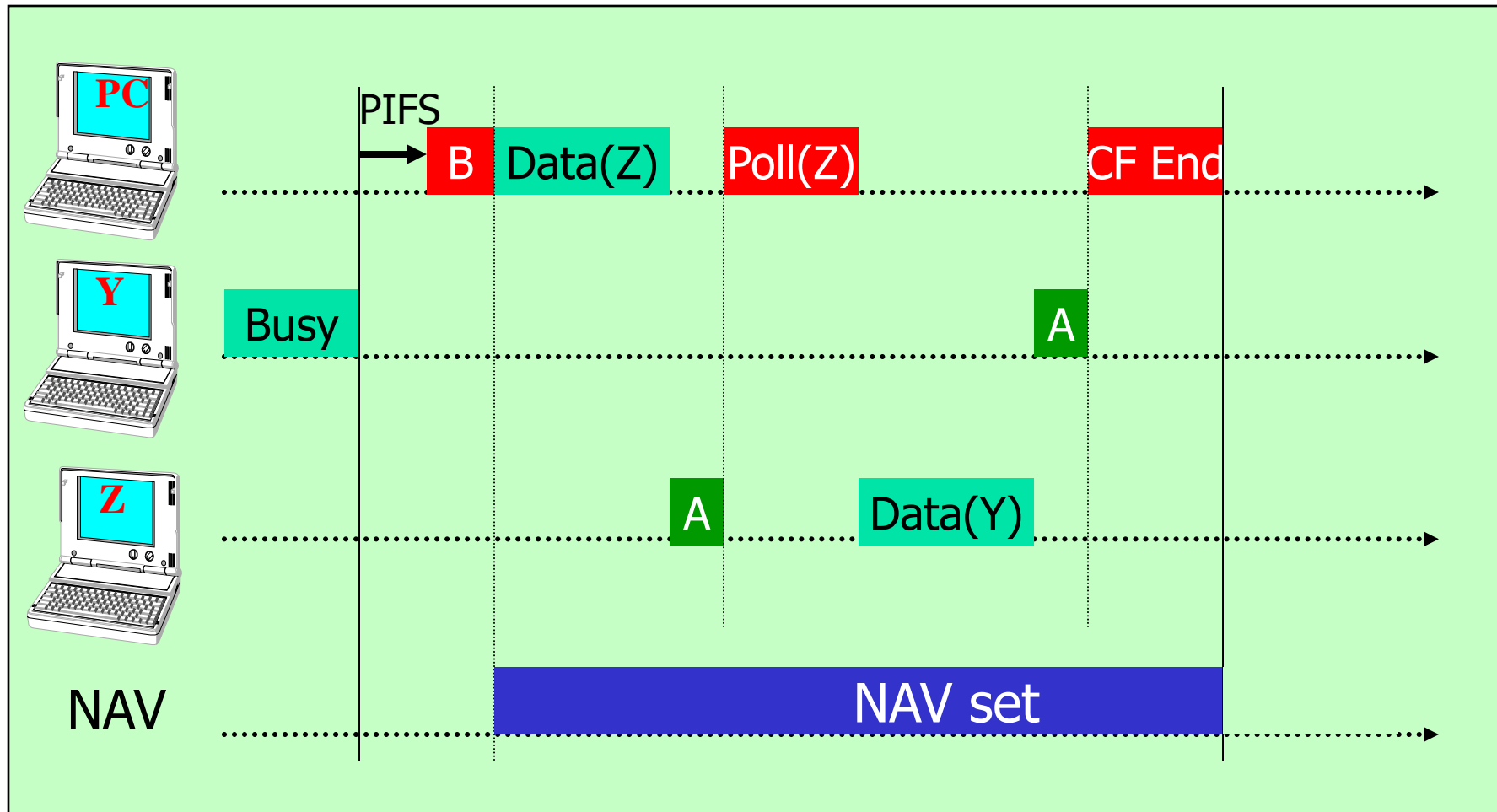

Accessing the Wireless Medium



- Two operation modes:
 - Distributed Coordination Function (DCF)
 - Point Coordination Function (PCF)
- The coexist of DCF & PCF
- PCF & DCF tradeoff



The coexist of DCF & PCF

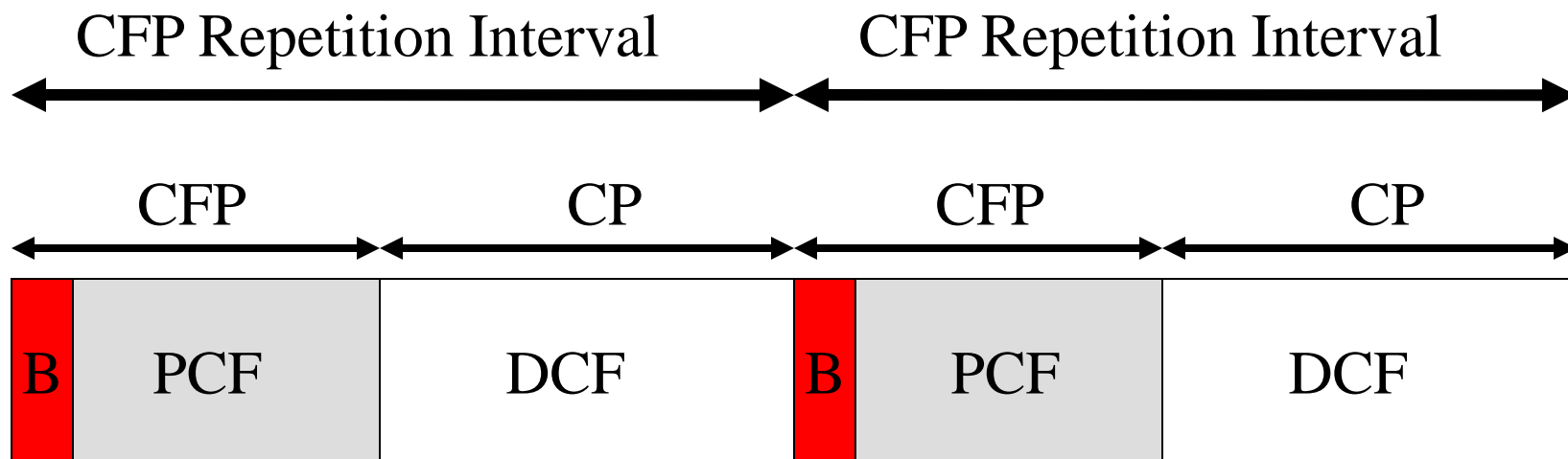

Accessing the Wireless Medium



- Two operation modes:
 - Distributed Coordination Function (DCF)
 - Point Coordination Function (PCF)
- The coexist of DCF & PCF
- PCF & DCF tradeoff



PCF & DCF tradeoff

- DCF by default, PCF is optional
- DCF cannot guarantee the transmission delay
- PCF is more suitable for QoS
- PCF needs to pay for the overhead (Poll)



MAC Layer Operations

- Accessing the wireless medium
- **Joining the network**
- Providing authentication and privacy



Startup/Join the network

- Turn on → discovery phase
 - determine AP or other stations exist
- If exist → join the network, get the following:
 - Service Set Id (SSID)
 - Timing Synchronization Function (TSF)
 - Timer Value
 - PHY setup parameters
- Negotiate for connection
 - Authentication & Association



Discovery Phase

- Enter scanning mode
 - Passive / Active scanning mode
- Passive
 - Listen for a Beacon for ChannelTime period
 - In Beacon → get the SSID & parameters
- Active
 - Transmit a probe frame (including the SSID that wishes to join)
 - Wait for a period responded by AP or other stations



MAC Layer Operations

- Accessing the wireless medium
- Joining the network
- **Providing authentication and privacy**



Authentication

- Open system authentication
 - Default mode
- Shared key authentication
 - Higher degree of security
 - More rigorous frame exchange
 - Need to implement WEP



Open System Authentication

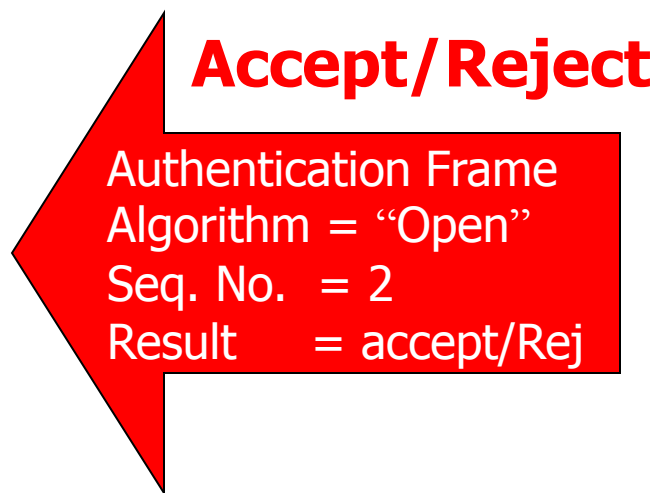
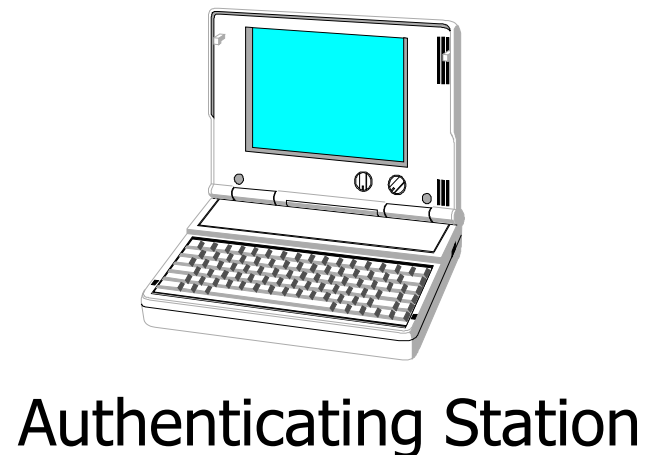
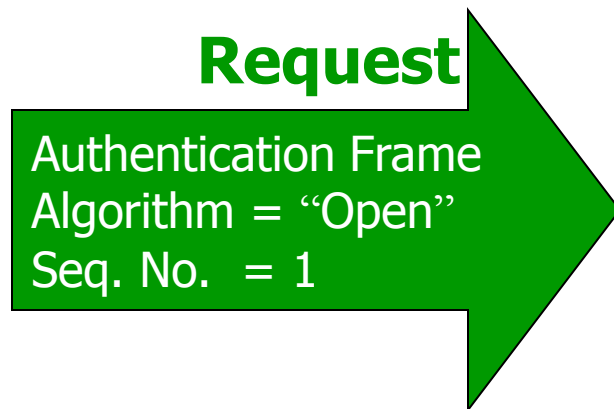



Shared Key Authentication

Algorithm = "Shared Key"
Seq. No. = 1

Algorithm = "Shared Key"
Seq. No. = 2
Challenge Text

Algorithm = "Shared Key"
Seq. No. = 3
Encrypt Challenge Text

Algorithm = "Shared Key"
Seq. No. = 4
Authen result

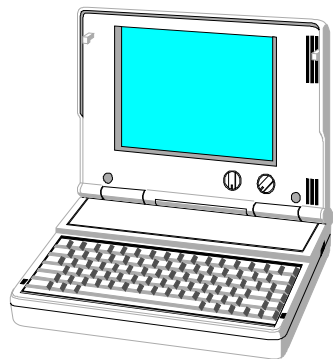

Initiating Station

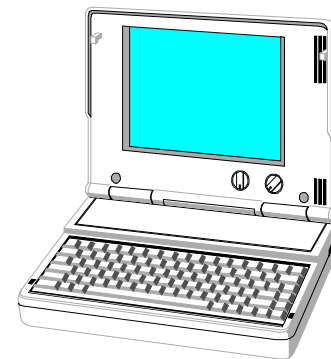

Authenticating Station



Wired Equivalent Privacy

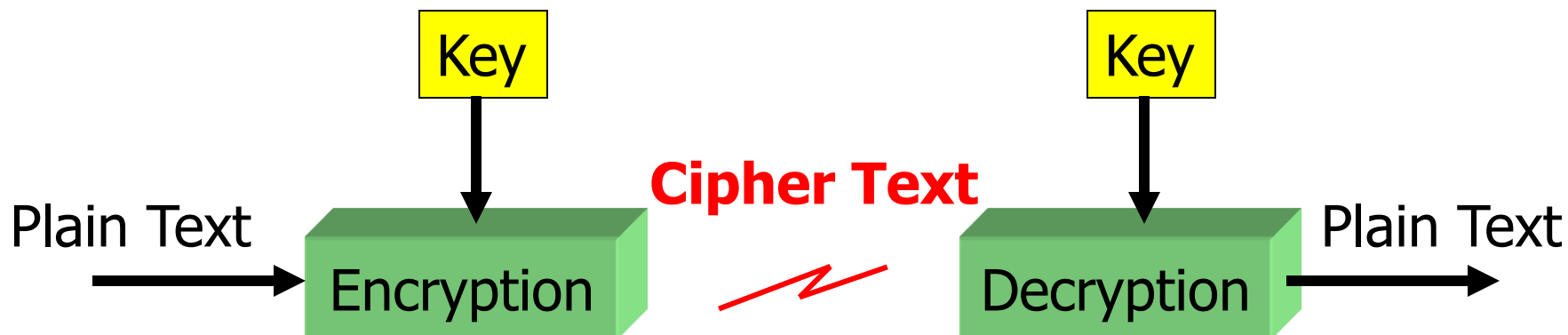

Symmetric Encryption



WEP - Encryption

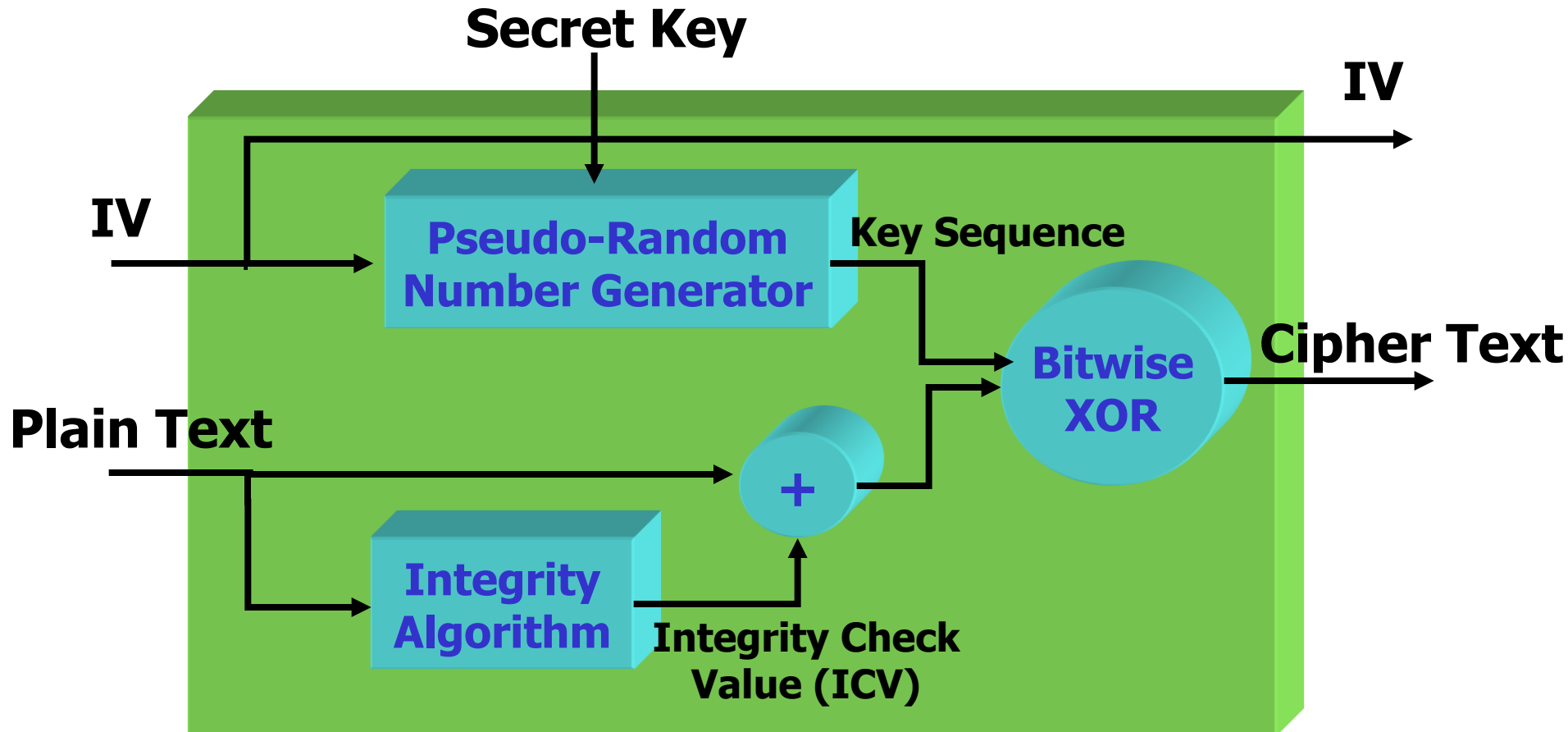



WEP Frame

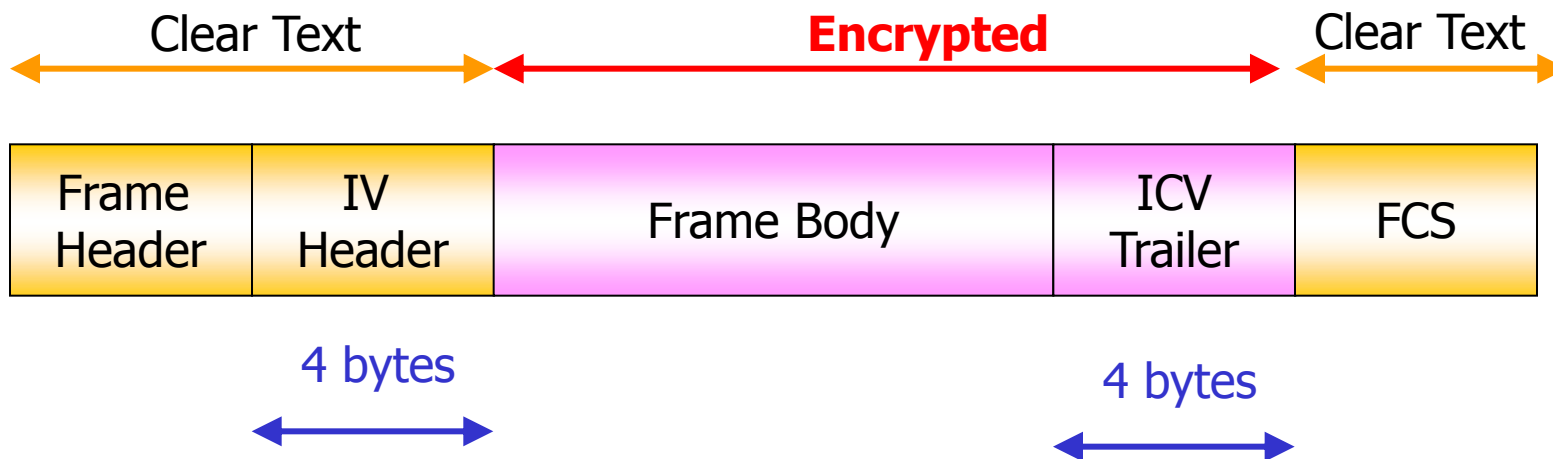



WEP - Decryption

